

Product Guide



PALMER Wahl
INSTRUMENTATION GROUP

America's First Manufacturer of Precision Industrial
Temperature and Pressure Instrumentation

www.palmerwahl.com

ISO 9001:2008
CERTIFIED QUALITY
MANAGEMENT SYSTEM



Wahl's Newest Heat Spy® Thermal Imagers



A

A. NEW! z150, a150 and z170, a170 Cameras

Ultra-High Sensitivity, Touch Screen, SpyLite, Picture-in-Picture and 2 Meter Drop Test
Frame Rate: "z" model: 60 Hz; "a" model: 9 Hz

Detector Resolution: Models **z150/a150:** 160 x 120; Models **z170/a170:** 384 x 288

Field of View: 25° x 19°

Spatial Resolution: Models **z150/a150:** 2.73 mrad; Models **z170/a170:** 1.37 mrad

Thermal Sensitivity @ 30°C: Models **z150/a150:** ≤ 0.05°C; Models **z170/a170:** ≤ 0.04°C

IR Digital Zoom: X 2 or X 4

Spectral Range: 8 to 14 µm

Visible Light Camera: 3.2 Megapixel CMOS Sensor, Dual LED Headlights

Thermal/Visible Light Image: Switch between Thermal, Visible Light, Picture-in-Picture¹, & SpyLite²

LCD Display / Palettes: High Resolution 3.6" Color LCD Touch Screen, 640 x 480 / 11 Color Palettes

Measurement Range: Menu Selectable -4° to 662°F (-20° to 350°C) or 212° to 1202°F (100° to 650°C)

Extended Temperature Options: 752° to 2192°F (400° to 1200°C) or 752° to 3632°F (400° to 2000°C) (170 only)

Measurement Accuracy: Greater of ± 2% of reading or ± 2°C, up to 650°C. Instrument not calibrated below 10°C

Measurement Correction: Auto / Manual

Measurement Mode: Spots, Areas, Lines, Isotherms, Delta T, Alarms (Multiple Audible, Visible)

Emissivity Correction: Adjustable from 0.01 to 1.00, Built-in Emissivity Table

Alarm: High and Low Temperature Audible and Visible Alarm; Isotherm Visible Alarm

Factory UPGRADE Optics:

Wide Angle Lens: 0.5X for a 50° x 38° FOV (150 & 170), or 0.25X for 100° x 76° FOV (170)

Telephoto Lens: 2X for 12.5° x 9.5° FOV (150 & 170), or 4X for 6.25° x 4.75° FOV (170)

¹ Picture-in-Picture - All temperatures shown thermally over visible image.

² SpyLite™ - Only temperatures over or under preset point shown thermally over visible image.

CAMERAS AT A GLANCE

Series	170	150	70	50	30*
Frame Rate - z models**	60 Hz	60 Hz	30 Hz	30 Hz	30 Hz
Frame Rate - a models	9 Hz	9 Hz	9 Hz	9 Hz	9 Hz
Detector Resolution	384 x 288	160 x 120	384 x 288	160 x 120	160 x 120
Number of Pixels	110,592	19,200	110,592	19,200	19,200
Field of View	25° x 19°	25° x 19°	25° x 19°	17.5° x 13°	17.5° x 13°
Spatial Resolution***	1.37 mrad	2.73 mrad	1.37 mrad	1.9 mrad	1.9 mrad
Thermal Sensitivity @ 30°C	≤ 0.04	≤ 0.05	≤ 0.06	≤ 0.1	≤ 0.1
Visible Camera Megapixels	3.2	3.2	1.3	1.3	with Upgrade
LCD Display Touch Screen	3.6" Color, Touch	3.6" Color, Touch	3.5" Color No	3.5" Color No	3.5" Color No
Palettes	11	11	11	11	4
Lens Options	Wide Angle, Telephoto	Wide Angle, Telephoto	NA	Wide Angle, Telephoto	Wide Angle, Telephoto
High Temperature	User Switchable	User Switchable	User Switchable	User Upgrade	User Upgrade
Extended Temperature Option	Yes	No	No	No	No
6 Foot Drop Test	Yes	Yes	No	No	No
Spy-Care	Yes	Yes	Yes	Yes	with Upgrade

* Upgradeable to a 50 Series Full Feature model - Anytime, in the Field.

** Export Licensing fee may be required for your country, subject to US Government approval. No Export License required on 9Hz models.

*** 384 x 288 not directly convertible to 640 x 480 imager display. Image displayed as 320 x 240 image. Full 384 x 288 resolution image, (1.09 mrad), downloads to computer.



FREE Lifetime Recalibration and Firmware Updates

FREE ANNUAL Lifetime Standard Calibration of your Heat Spy Thermal Imager is included with your purchase – a savings of up to \$250 for each calibration. Contact us to obtain an RMA number to return your unit to Wahl. We will calibrate it and install any new firmware updates at no charge. Customer pays shipping both ways. *Free Recalibration of wide angle or telephoto lenses is not included in this offer as there is an additional charge to ensure your unit is properly calibrated to your specific lenses. Call for details regarding calibration of these lenses.

FREE Thermography Training

Wahl offers free thermography training on a monthly basis at our Asheville, NC, USA facility. This eight hour intensive course will train you to interpret thermal images. Training is available to anyone, whether you own a Heat Spy or not. Presented by our T/IRT Level II Certified Trainers, this training is invaluable to anyone. *Space is limited and available on a first come, first serve basis. Customer pays own expenses. Visit our website for training dates.*

FREE Competitor Camera Loaner Program

Do you own a competitor's thermal imager that is in for repair? Repairs can be slow, leaving you without an important tool for an extended period of time. Take advantage of Wahl's FREE Competitive Camera Loaner Program. Submit proof of your instrument's return for repair (e.g., RMA paperwork) and Wahl will loan you a Heat Spy 50 Series Inspector for use for up to 30 days, FREE. *USA ONLY. Customer pays shipping both ways. Quantities are limited, and based on availability; subject to credit approval. Loaner Heat Spy must be secured by a company credit card and purchase order.*

FREE Emergency Replacement Service

Heat Spy Imager owners can rest assured that they will always have a thermal imaging camera on hand. If your Heat Spy is in for repair – and you need it – we will send you a replacement camera to use in the meantime – FREE. You never have to worry about being without your most useful tool. **USA and Canada ONLY. Customer pays shipping both ways.*

Specifications subject to change without notice

B. NEW! z70 and a70 CHIEF Inspector

Designed for the highest detail, save and export thermal and digital images with easy report writing

Frame Rate: "z" model: 30 Hz; "a" model: 9 Hz **Detector Resolution:** 384 x 288
Field of View: 25° x 19° **Spatial Resolution:** 1.37 mrad
Thermal Sensitivity: 0.06°C @ 30°C **IR Digital Zoom:** X 2 or X 4

Spectral Range: 8 to 14 µm

Visible Light Camera: 1.3 Megapixel CMOS Sensor

Thermal/Visible Light Image: Toggle between Thermal and Visible Light

LCD Display / Palettes: High Resolution 3.5" Color LCD Screen, 640 x 480 / 11 Color Palettes

Measurement Range: User Switchable Low/High Temperature

-4° to 356°F (-20° to 180°C) or 212° to 1112°F (100° to 600°C)

Measurement Accuracy: Greater of ± 2% of reading or ± 2°C, Instrument not calibrated below 10°C

Measurement Correction: Auto Correction with Adjustable Time Interval or Push Button Manual

Measurement Mode: Spots, Areas, Lines, Isotherms, Delta T, Alarms (Multiple Audible, Visible)

T Reflect: Manual Adjustment **T Correct:** Manual Adjustment

Emissivity Correction: Adjustable from 0.01 to 1.00, Built-in Emissivity Table

Alarm: High and Low Temperature Audible and Visible Alarm; Isotherm Visible Alarm



B, C, & D

**FREE Unlimited
Phone Support
with all cameras!**



C. z50 and a50 Inspector

Designed for higher detail and report analysis, but at half the cost

Frame Rate: "z" model: 30 Hz; "a" model: 9 Hz **Detector Resolution:** 160 X 120

Field of View: 17.5° x 13° **Spatial Resolution:** 1.9 mrad

Thermal Sensitivity: 0.1°C @ 30°C **IR Digital Zoom:** X 2

Spectral Range: 8 to 14 µm

Visible Light Camera: 1.3 Megapixel CMOS Sensor

Factory UPGRADE Optics: Wide Angle: (35° x 26° FOV); Telephoto: (8.75° x 6.5° FOV)

Thermal/Visible Light Image: Toggle between Thermal and Visible Light

LCD Display / Palettes: High Resolution 3.5" Color LCD Screen, 640 x 480

Measurement Range: -4° to 356°F (-20° to 180°C), **User Upgrade to High Temperature:** 212° to 1112°F (100° to 600°C)

Measurement Accuracy: Greater of ± 2% of reading or ± 2°C, Instrument is not calibrated below 10°C

Measurement Correction: Auto Correction of Microbolometer with Adjustable Time Interval or Push Button Manual

Measurement Mode: Spots, Areas, Lines, Isotherms, Delta T, Alarms (Multiple Audible, Visible)

T Reflect: Manual Adjustment **T Correct:** Manual Adjustment

Emissivity Correction: Adjustable from 0.01 to 1.00, Built-in Emissivity Table

Alarm: High Temperature Audible and Visible Alarm, Isotherm Visible Alarm

D. z30 and a30 Detector - the only UPGRADEABLE CAMERA IN THE WORLD!

Designed for on the spot routine maintenance inspections USER UPGRADEABLE to a 50 Series Model

Frame Rate: "z" model: 30 Hz; "a" model: 9 Hz **Detector Resolution:** 160 X 120

Field of View: 17.5° x 13° **Spatial Resolution:** 1.9 mrad

Thermal Sensitivity: 0.1°C @ 30°C **IR Digital Zoom:** X 2

Spectral Range: 8 to 14 µm

Visible Light Camera: Available with Upgrade

Factory UPGRADE Optics: Wide Angle: (35° x 26° FOV);
Telephoto: (8.75° x 6.5° FOV)

Thermal/Visible Light Image: Available with Upgrade

LCD Display: High Resolution 3.5" Color LCD Screen, 640 x 480

Display Color Palettes: 4 Color Palettes (11 with Upgrade)

Measurement Range: -4° to 356°F (-20° to 180°C),

User Upgrade to High Temperature: 212° to 1112°F (100° to 600°C)

Measurement Accuracy: Greater of ± 2% of reading or ± 2°C, Instrument not calibrated below 10°C

Measurement Correction: Auto Correction with Adjustable Time Interval or Push Button Manual

Measurement Mode: Spots, Delta T, High Temperature Alarm (Additional Functions with Upgrade)

T Reflect: Manual Adjustment **T Correct:** Available with Upgrade

Emissivity Correction: Adjustable from 0.01 to 1.00, (Built-in Emissivity Table with Upgrade)

Alarm: High Temperature Audible and Visible Alarm, (Isotherm Visible Alarm with Upgrade)

**Lease the Wahl Heat Spy
Zero down, Zero interest, over 2 years!**

Investigate at
www.wahlheatspy.com
and see what you've been missing!

Introducing SPY-CARE™

**THE FIRST NO-FAULT THERMAL IMAGER
WARRANTY IN THE INDUSTRY**

**Repaired or replaced free for two years,
for any reason!**

The Industry's **FIRST No-Fault Warranty** now comes with each Heat Spy Thermal Imager sold*. SPY-CARE™ is 2 year, NO-FAULT warranty protection. If any unintentional and unavoidable damage occurs - Wahl will fix or replace your camera for FREE. This protection is for the duration of the warranty period of two years from the original purchase date. Get unlimited repairs and one replacement camera (if camera cannot be repaired) during the two year warranty period.

* Spy-Care™ covers units sold worldwide, and does not include shipping and handling charges. Customer pays shipping both ways. Customers outside the USA are required to pay export licensing fee, if applicable. No export license required with 9 hertz models. Spy-Care™ covers only the camera, and does not cover any included or additional accessories, including but not limited to batteries, lenses or SD cards. Spy-Care™ does not cover the 30 Series camera which is covered by the standard warranty. Spy-Care™ does not cover any intentional or avoidable damage, such as disassembly. Intentional damage will void any warranty coverage.

**WAHL'S
NO-FAULT
WARRANTY
GUARANTEE**

Heat Spy® is a registered trademark of Wahl Instruments, Inc.

Heat-Spy® Infrared Thermometers

Portable non-contact infrared thermometers from the company that first introduced them!



A. DHS85XL

Type: Close Range
Accuracy: ± 2% of reading
Repeatability: ± 2°F (± 1°C)
Display: LCD with Backlight
Display Resolution: 0.1°F (0.1°C)

Range: -4° to 619°F; (-20° to 326°C)
Distance to Spot: 8:1
Spectral Range: 5 to 14 μm
Emissivity: Fixed at 0.95
Sighting: Laser Switchable

B. DHS115XL or DHS115XEL

Type: Mid Temperature, Short Range
Accuracy: ± 5°F (± 3°C) from -25° to -4°F
 ± 3°F (± 2°C) from -4° to 212°F
Repeatability: ± 2°F (± 1°C)
Display: LCD with Backlight
Display Resolution: 0.1°F (0.1°C)

Range: -25° to 999°F; (-32° to 535°C)
Distance to Spot: 12:1
Spectral Range: 5 to 14 μm
Emissivity: DHS115XL: Fixed
 DHS115XEL: Adjustable 0.10 to 1.00
Sighting: Laser Switchable

C. DHS135XEL

Type: High Temperature, Long Range, Plus
Accuracy: ± 5°F (± 3°C) from -58° to -4°F
 ± 3°F (± 2°C) from -4° to 212°F
 ± 2% above 212°F
Repeatability: ± 2°F (± 1°C)
Display: Dual Display LCD with Backlight

Range: -58° to 1832°F; (-50° to 1000°C)
Distance to Spot: 30:1
Spectral Range: 8 to 14 μm
Emissivity: Adjustable 0.10 to 1.00
Sighting: Laser Switchable
Display Resolution: 0.1°F (0.1°C)

D. DHS215XEL, USB & Type K Probe (not pictured)

Type: High Temperature, Extra Long Range
Accuracy: ± 5°F (± 3°C) from -58° to -4°F
 ± 3°F (± 2°C) from -4° to 212°F
 ± 2% above 212°F
Repeatability: ± 2°F (± 1°C)
Display: Dual Display LCD with Backlight

Range: -58° to 1832°F; (-50° to 1000°C)
Distance to Spot: 50:1
Spectral Range: 8 to 14 μm
Emissivity: Adjustable 0.10 to 1.00
Sighting: Laser Switchable
Display Resolution: 0.1°F (0.1°C)

E. DHS235XEL (not pictured)

Type: Extra High Temp, Extra Long Range, Plus
Accuracy: ± 5°F (± 3°C) from -58° to -4°F
 ± 3°F (± 2°C) from -4° to 212°F
 ± 2% above 212°F
Repeatability: ± 2°F (± 1°C)
Display: Dual Display LCD with Backlight

Range: -58° to 2732°F; (-50° to 1500°C)
Distance to Spot: 50:1
Spectral Range: 8 to 14 μm
Emissivity: Adjustable 0.10 to 1.00
Sighting: Laser Switchable
Display Resolution: 0.1°F (0.1°C)

F. DHS520B

Type: High Precision, High Temperature
Accuracy: < 0.25% (K) of reading
Repeatability: < 0.1% (K) of reading
Display: LCD
Optical System: 9° Field of View
Output: Bluetooth Communications

Range: 1022° to 5432°F (550° to 3000°C)
Distance to Spot: 20:1, 4:1 with closeup lens
Spectral Range: 1 μm with advance spectral filtering
Emissivity Adj: 0.10 to 1.00 in 0.01 step graduations
Sighting: Optical, Thru the Lens
Approvals: CE Mark, IP54, NEMA 3
Options: Dark Glass Eye Protection Filter

G. DHS125XEL, Type K Probe

Type: Hybrid Infrared
Accuracy: ± 5°F (± 3°C) From -25° to -4°F
Repeatability: ± 2°F (± 1°C)
Display: LCD with Backlight
Display Resolution: 0.1°F (0.1°C)

Range: -25° to 1400°F (-32° to 760°C)
Distance to Spot: 12:1
Spectral Range: 5 to 14 μm
Emissivity: Adjustable 0.1 to 1.0
Sighting: Laser Switchable



Specifications subject to change without notice



K

High Performance Infrareads

DHS24, DHS26, DHS28, DHS29 & DHS35 Heat Spy Infrared Thermometers are the most durable, advanced, easy to use infrareads in the world! Featuring precision ground mirrors and rare-earth germanium filters, the patented detector gives an accuracy of better than $\pm 0.3\%$ of full scale, with 1°F or $^\circ\text{C}$ resolution.



H



L

H. DHS24 or DHS24X

Type: High Performance
Accuracy: $\pm 0.3\%$ of Full Scale
Distance to Spot: 20:1
Repeatability: $\pm 1^\circ\text{F}$
Display: LED, "X" models LCD
Options: Laser Sighting, NIST Traceability

Range: 0° to 1000°F , (-20° to 550°C)
Spectral Range: 8 to $14\ \mu\text{m}$
Emissivity: Adjustable 0.2 - 1.0
Sighting: Enclosed Optical
Display Resolution: 1°F or $^\circ\text{C}$

I. DHS26 or DHS26X (not pictured)

Type: High Performance
Accuracy: $\pm 0.3\%$ of Full Scale
Distance to Spot: 20:1
Repeatability: $\pm 2^\circ\text{F}$
Display: LED, "X" models LCD
Options: Laser Sighting, NIST Traceability

Range: 0° to 2000°F , (-20° to 1000°C)
Spectral Range: 8 to $14\ \mu\text{m}$
Emissivity: Adjustable 0.2 - 1.0
Sighting: Enclosed Optical
Display Resolution: 1°F or $^\circ\text{C}$

J. DHS28X (not pictured)

Type: High Performance
Accuracy: $\pm 0.3\%$ of Full Scale
Distance to Spot: 20:1
Repeatability: $\pm 3^\circ\text{F}$
Display: LCD
Options: NIST Traceability

Range: 32° to 2500°F , (0° to 1380°C)
Spectral Range: 8 to $14\ \mu\text{m}$
Emissivity: Adjustable 0.2 - 1.0
Sighting: Enclosed Optical
Display Resolution: 1°F or $^\circ\text{C}$

K. DHS29X or DHS29XT

Type: High Performance
Accuracy: $\pm 0.3\%$ of Full Scale
Distance to Spot: 100:1
Repeatability: $\pm 3^\circ\text{F}$
Display: LCD
Options: NIST Traceability

Range: 900° to 3200°F , (482° to 1760°C)
Spectral Range: 2.1 to $2.5\ \mu\text{m}$
Emissivity: Adjustable 0.2 - 1.0
Sighting: Enclosed Optical, "XT" models Telescopic
Display Resolution: 1°F or $^\circ\text{C}$

L. DHS35XT

Type: High Performance
Range: 800° to 3200°F , (426° to 1760°C)
Accuracy: $\pm 0.5\%$ of Full Scale
Spectral Range: 3.5 to $4.1\ \mu\text{m}$
Distance to Spot: 100:1
Emissivity: Adjustable 0.2 - 1.0
Repeatability: $\pm 3^\circ\text{F}$
Sighting: Telescope
Display: LCD
Display Resolution: 1°F or $^\circ\text{C}$
Options: NIST Traceability

You know those cool gun-style thermometers?



A gun? Yes, to get temperatures

It looks like a pistol with a king-size barrel. Actually, it's a thermometer that registers the surface temperature of any object, without contact, from 60 to 3,000 degrees. It responds to infrared energy emissions. Made by the William Wahl Corp., it's called a Heat Spy.

We invented them...

In the 1960's Wahl developed the first portable non-contact infrared thermometer. Featured in Popular Science magazine in 1967, the Wahl Heat Spy Infrareads have been an industry standard, and we've been improving on them ever since. Today we offer a full line of innovative and economical infrareads to suit any application.

Heat Spy® is a registered trademark of Wahl Instruments, Inc.

Heat-Spy® Infrared Thermometers

The most affordable High Temperature and Long Distance hand held infrareds on the market



B



C



High Temperature Infrareds

A. DHS1900

Type: Extra High Temperature for the Steel Industry
Range: 662° to 3452°F (350° to 1900°C)
Distance to Spot: 150:1
Spectral Range: 1.6 μm
Emissivity: Adjustable 0.1 to 1.0
Repeatability: $\pm 5\%$ of Reading
Resolution: 1°F or °C
Output: 4-20 mA; RS485; Mini USB port below the LCD
Calculation: MAX/MIN/AVG/Delta T calculations
Alarm: Includes Hi, Low Alarms

B. DHS3000 (same housing as DHS1900)

Type: Super High Temperature for the Aluminum Industry
Range: 1112° to 5432°F (600° to 3000°C)
Distance to Spot: 150:1
Spectral Range: 1 μm
Emissivity: Adjustable 0.1 to 1.0
Repeatability: $\pm 5\%$ of Reading
Resolution: 1°F or °C
Output: 4-20 mA; RS485; Mini USB port below the LCD
Calculation: MAX/MIN/AVG/Delta T calculations
Alarm: Includes Hi, Low Alarms

Long Distance Infrared

C. HSA300

Type: Long Distance for Power Generation and Transmission Industry
Range: 0° to 572°F (-18° to 300°C)
Distance to Spot: 300:1; 2-inch measurement spot at 50 feet, its telescopic sight allows precise positioning of the measurement spot
Spectral Range: 8 to 14 μm
Emissivity: Adjustable 0.5 to 1.0
Repeatability: $\pm 2\%$ of Reading
Resolution: 1°F or °C
Measurement: Accurate at distances from 20 to 50 ft
Display: Peak temperature is displayed on the large main display easing the ability to capture the hot spot; Current temperature is displayed on the smaller secondary display

ONE YEAR
1
WARRANTY

THE LONGEST DISTANCE PORTABLE INFRARED IN THE WORLD

Our new HSA300 is the world's only 300:1 portable long distance thermometer, enabling users to safely and accurately measure temperature beyond the range of typical models. Developed to search out and measure small targets at a safe distance for maintenance and repair before failure, the HSA300 is a perfect trouble-shooter for high voltage connections, transformers, smoke stacks and reactors. Precise target definition and instant response makes this an ideal instrument with all the features preferred by maintenance engineers to easily search out hot spots at a safe and convenient distance.

Heat Spy® is a registered trademark of Wahl Instruments, Inc.

Heat Spy® Monitor

Fixed Infrared Pyrometers Specifically designed for easy maintenance and high performance in harsh industrial environments, these sensors offer quick and easy integration into process measurement and control systems for non-contact temperature measurement of non-metallic surfaces or painted, coated or anodized metals.



A. M45 Series Fiber Optic Infrared Sensors

Ranges: 300° to 3200°C (572° to 5792°F)

Sighting: Laser or LED Sighting

Spectral Range: 1.6 μm , 1 μm , and Two Color 0.7 to 1.15 μm

Accuracy: Models offer $\pm 0.3\%$ Rdg +1°C and $\pm 0.5\%$ Rdg +1°C

Response Time: 2 mS and 20 mS

Distance to Spot: 40:1, 80:1, 100:1, 180:1

B. M35 Series Heavy Duty Industrial Infrared Sensors

Ranges: 260° to 3200°C (500° to 5792°F)

Sighting: Optional Laser or Thru the Lens Sighting

Spectral Range: 1.6 μm , 1 μm , and Two Color 0.7 to 1.15 μm

Accuracy: Models offer $\pm 0.3\%$ Rdg +1°C and $\pm 0.5\%$ Rdg +1°C

Response Time: 2 mS and 20 mS

Distance to Spot: 50:1, 100:1 or 200:1

C. M35 Series Heavy Duty Industrial Infrareds, Optional Optics

Range: 0° to 1000°C (32° to 1832°F)

Sighting: Laser Sighting

Spectral Range: 8 to 14 μm

Accuracy: $\pm 1.5\%$ of Reading or 3.6°F (2°C)

Response Time: 60 mS

Distance to Spot: 50:1

D. M30 Series Compact Low Temperature Infrared Sensors

Ranges: 0° to 400°C (32° to 752°F)

Sighting: No Sighting

Spectral Range: 8 to 14 μm

Accuracy: $\pm 2\%$ Rdg or 1°C

Response Time: 300 mS

Distance to Spot: 12:1

E. M20 Series Optical Head Infrared Sensors with Display

Ranges: 0° to 2500°C (32°F to 4532°F)

Sighting: LED or Optional Laser

Spectral Range: 1.6 μm , 1 μm , Two Color 0.7 to 1.15 μm , 8 to 14 μm

Accuracy: $\pm 0.3\%$ Rdg +1°C, $\pm 0.5\%$ Rdg +1°C, $\pm 1.5\%$ Rdg or +2°C

Response Time: 10 mS, 20 mS, 60 mS

Distance to Spot: 2:1, 15:1, 20:1, 40:1, 80:1

F. M15 Series Infrared Sensors with Coaxial

Laser Sighting (not pictured)

Ranges: 0° to 1200°C (32°F to 2192°F)

Sighting: Coaxial Laser Sighting

Spectral Range: 1.6 μm , 8 to 14 μm

Accuracy: $\pm 1\%$ of Full Span

Response Time: 500 mS, 200 mS

Distance to Spot: 30:1, 80:1



Specifications subject to change without notice

Digi-Stem[®] Thermometers

DST600 Series Industrial RTD Meters and Probes, designed for temperature critical applications. Proudly made in the USA.

A. Digi-Stem Thermometer Systems with Two Independent Class A 4-wire RTD's

Model: DST610: Direct Access RTD Output

Range: -50° to 500°F (-45.5° to 260°C), User Selectable °F or °C

Meter Accuracy: ± 0.1°F/C, over 1 year period (@Tamb = 23°C ± 5°C), Self-Checking

Sensing Element: Class A, 4-wire RTD with Isolated Secondary 4 Wire RTD

Case Material: NEMA 4X 300 Series Stainless Housing

Probes: Probe ID to verify probe, Welded & Spring Loaded

Probe Connection: Dual Port Case with secondary RTD, wired to an internal terminal

block, access to the isolated second RTD via a 1/2" NPT fitting

Power: Battery Powered Local LCD Display with 1" Digits

Display Resolution: 0.1°F or °C

Accessories: DSTCAL Calibration Software, Battery Types, NIST Certifications, and Mounting Equipment

Model: DST611: Direct Access RTD Output

Range: -50° to 500°F (-45.5° to 260°C), User Selectable °F or °C

Meter Accuracy: ± 0.1°F/C, over 1 year period (@Tamb = 23°C ± 5°C), Self-Checking

Sensing Element: Class A, 4 wire RTD with Isolated Secondary 4 Wire RTD

Case Material: NEMA 4X 300 Series Stainless Housing

Probes: Probe ID to verify probe, Welded & Spring Loaded

Probe Connection: Dual port case with secondary RTD wired to an internal terminal block. Turck 4 pin connector on second port for watertight access

Power: Battery Powered Local LCD Display with 1" Digits

Display Resolution: 0.1°F or °C

Accessories: DSTCAL Calibration Software, Battery Types, NIST Certifications, and Mounting Equipment

Model: DST620: 4-20 mA Transmitter Output

Range: -50° to 500°F (-45.5° to 260°C), User Selectable °F or °C

Meter Accuracy: ± 0.1°F/C, over 1 year period (@Tamb = 23°C ± 5°C), Self-Checking

Sensing Element: Class A, 4 wire RTD with Isolated Secondary 4 Wire RTD

Case Material: NEMA 4X 300 Series Stainless Housing

Probes: Probe ID to verify probe, Welded & Spring Loaded

Probe Connection: Dual Port Case with Secondary RTD wired to internal programmable 4-20 mA transmitter, accessed via a 1/2" NPT fitting

Power: Battery Powered LCD Display with 1" Digits

Display Resolution: 0.1°F or °C

Accessories: DSTCAL Calibration Software, Battery Types, NIST Certifications, and Mounting Equipment

Model: DST621: 4-20 mA Transmitter Output

Range: -50° to 500°F (-45.5° to 260°C), User Selectable °F or °C

Meter Accuracy: ± 0.1°F/C, over 1 year period (@Tamb = 23°C ± 5°C), Self-Checking

Sensing Element: RTD with Isolated Secondary 4 Wire RTD

Case Material: NEMA 4X 300 Series Stainless Housing

Probes: Probe ID to verify probe, Welded & Spring Loaded

Probe Connection: Dual ports with a secondary RTD wired to internal programmable 4-20 mA transmitter. Turck 4 pin connector on second port for watertight access

Power: Battery Powered LCD Display with 1" Digits

Display Resolution: 0.1°F or °C

Accessories: DSTCAL Calibration Software, Battery Types, NIST Certifications, and Mounting Equipment

The Wahl DST600 offers the highest precision temperature measurement technology with many unique features - making it the best choice for your processing needs.

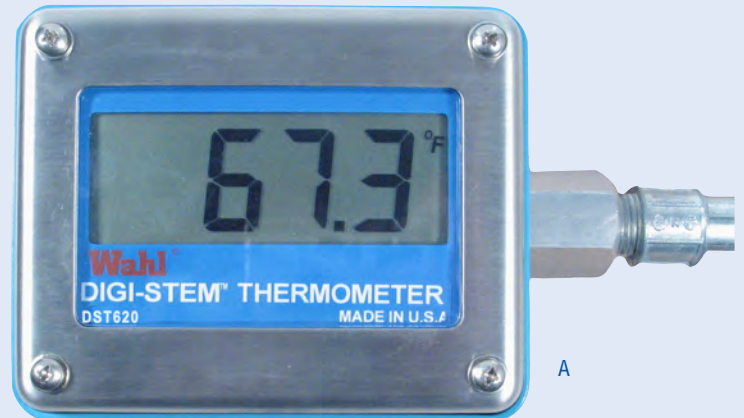

Exclusive Quick Disconnect option allows for removal of probe and meter for calibration without removing the permanently installed cable.



Specifications subject to change without notice

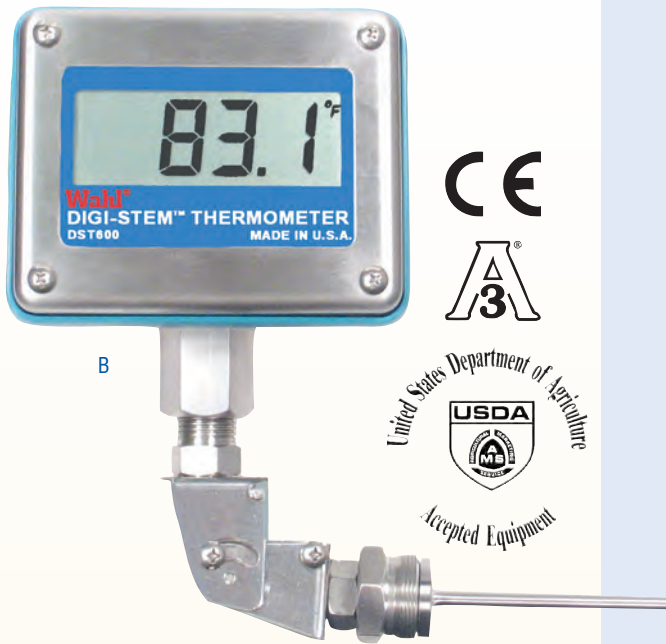

Unique Features of the DST600

Always Accurate Self-checking Technology

The Wahl DST600 meets and exceeds the FDA rules with patent-pending, self-checking technology which continuously verifies the accuracy of the electronics and indicates any out-of-tolerance conditions. This assures that its accuracy and ability to function properly during processing are not compromised.

Eliminates Electric Power Connections

- Sample/Display Rate - Factory default at 2/second. Adjustable from .25 seconds to 10 seconds in .25 second intervals. Slower update rates extend battery life up to 10 years.

Unique Probe ID - Prevents the use of unauthorized and uncalibrated probes, and verifies that only the authorized probe is connected to the meter. If an unauthorized probe is connected, the meter will indicate the need to perform the probe authorization and probe calibration functions. Probe ID is available on Adjustable Angle, Rigid, and Remote probes up to 25-meter cable lengths.

No other thermometer has these safety features!

Unique Probe R0 - Matches sensor to meter with Programmable "R0" for precise temperature readings. This exclusive compensation feature utilizes a programmable R0 calibration coefficient for increased accuracy. In conjunction with the Probe ID feature, it assures an accurate and secure system.

DSTCAL Calibration Software - This exclusive software allows setting of configuration parameters and allows the following calibrations:

- Meter Calibration - uses fixed resistances to calibrate the resistance measurement electronics.
- System Calibration - used to calibrate a sensor to a meter using a standard ice bath.

Easy Installation and Recalibration with Exclusive Quick Disconnect Connector Option on Remote Cables (pictured at left)

Optional Quick Disconnect for both probe and meter connections offers convenient calibration for the user. This industry leading, time saving capability, allows the probe and the meter to be removed and taken to the calibration lab and calibrated as a system - without removing the installed cable.

NOTE ABOUT PURCHASING: Digi-Stem Probes are custom built to your specifications and must be ordered separately from the meter to compose a complete system.



B. Digi-Stem RTD Thermometer Systems for Food Processing - with Self-Checking Technology

Model: DST600 for Retorts

Range: -50° to 500°F (-45.5° to 260°C), User Selectable °F or °C

Meter Accuracy: Greater of $\pm 0.3^\circ\text{F}/0.2^\circ\text{C}$ or $\pm 0.1\%$ of reading, over 1 year period (@ Tamb = 23°C \pm 5°C), Self-Checking

Sensing Element: Class A wire RTD

Case Material: NEMA 4X 300 Series Stainless Housing

Probes: 1-1/4"-18 Swivel Nut Fitting with 1/4" Diameter Stem, 1-1/4"-18 Swivel Nut Fitting & Tapered Bulb, Sanitary, Welded and Spring Loaded

Probe Connection: Rigid, Remote, Adjustable Angle

Power/Update Rate: Battery Powered / 2 second standard, adjustable in .25 second intervals from .25 to 10 seconds

Display Resolution: 0.1°F or °C with 1" Digits

Approvals: Meets FDA Specifications, USDA Approved Equipment, CE Mark, 3A Mark

Accessories: DSTCAL Calibration Software, Battery Type, NIST Certifications, and Remote Bracket Mounting

NOTE ABOUT PURCHASING: Digi-Stem Probes are custom built to your specifications and must be ordered separately from the meter to compose a complete system.



DIGI-STEM THERMOMETERS HELP MAKE A TASTY CAN OF BEANS!

In 2006 when the FDA proposed a rule change to allow for the use of digital thermometers in place of traditional mercury-in-glass thermometers during the canning process, Wahl began development of a reliable digital reference thermometer.

A near-by food processor, who has been canning their world-famous beans in locations across the USA for over 100 years, served as the beta-test site for this thermometer. With their focus on producing a large quantity of high quality product, they required a reliable thermometer compliant with both FDA and USDA rules. By opening their facilities to us, they were a valuable participant that enabled Wahl to develop a highly reliable digital 4-wire RTD thermometer.

The Wahl DST600 Digi-Stem Thermometer not only meets, but exceeds FDA and USDA rules. It incorporates self-checking technology to continuously verify accuracy and indicate any out-of-tolerance conditions. It also has a unique security feature which verifies that only an authorized probe is connected to the meter, and that the probe and meter are calibrated together to work as a system. These features guarantee an unrivaled accurate, reliable and secure system. This extra level of assurance provides peace of mind during processing so that our customer continues to produce a high quality - and tasty! - can of beans.

Digi-Stem® is a registered trademark of Wahl Instruments, Inc.

Digi-Stem® Thermometers

Optional FM, Max-Min, Transmitter, and multiple Thermocouples Systems

Digi-Stem® Features

- Selectable Stems, Rigid, All Angle and Remote
- Large 1" LCD Continuous Display
- Easy to Read from Over 20 Ft.
- Battery Operated
- Meter Accuracies from $\pm 0.3^{\circ}\text{F}$ ($\pm 0.2^{\circ}\text{C}$)
- Factory Calibration Lot Traceable to NIST (Optional)
- Direct Replacement for Bimetal, Mercury-in-Glass, Bulb & Capillary Thermometers
- Temperature Ranges from -328° to 1472°F (-200° to 800°C)
- Easy to Install
- NEMA-4X Stainless Housing
- Hose-Down Proof, Vibration Tolerant
- Optional RTD or Thermocouple Output
- 4-20 mA Transmitter with Local Display, Loop Power



A1

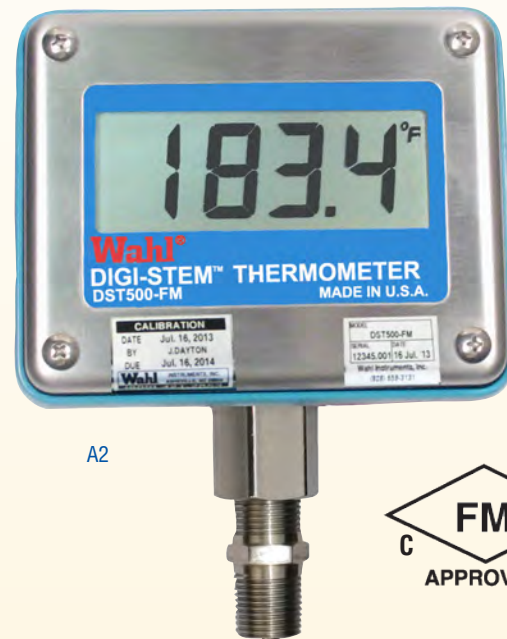

A2



B

A. Digi-Stem RTD Thermometers with optional FM or Min-Max

A1 Model: DST500 Meter **A2 Model:** DST500-FM Meter with Factory Mutual Approval

A3 Model: DST550 Min-Max Recording Meter (not pictured)

Range: -328° to 1472°F (-200° to 800°C)

Meter Accuracy: $\pm 0.1^{\circ}\text{F}$ or $^{\circ}\text{C}$, over 1 year period (@ $T_{\text{amb}} = 23^{\circ}\text{C} \pm 5^{\circ}\text{C}$)

System Accuracy: DST500-FM: from $\pm 0.3^{\circ}\text{F}$

Sensing Element: Class A, 4 Wire RTD

Case Material: NEMA 4X 300 Series Stainless Housing

Probes: IP68 Remote Cable Connection System; 1/4", 3/8", or 1/2" Diameter, Tapered Bulb, Sanitary, Spring Loaded, Welded

Probe Connection: Rigid, Adjustable Angle, or Remote

Power: Battery Powered Display; DST500-FM: when used with the Wahl DSA3060 (Tadiran model TL-2200) battery, carries hazardous location approval for US and Canada

Display Resolution: 0.1°F or $^{\circ}\text{C}$. 1°F above 999.9°F

Accessories: DSTCAL Calibration Software, Battery Types, NIST Certifications, and Remote Mounting Bracket

Approvals: CE Approval on DST500 only

DST500-FM: Intrinsically Safe IS/CL I, II, III / DIV 1 / GP ABCDEFG / T4A $T_a = 70^{\circ}\text{C}$; Type 4X

CL I, II, III / DIV 2 / GP ABCDEFG / T4A $T_a = 70^{\circ}\text{C}$; Type 4X

B. Digi-Stem RTD Thermometer & Transmitter System

Model: DSX500 Meter with 4-20 mA Transmitter

Range: -328° to 1472°F (-200° to 800°C)

Meter Accuracy: $\pm 0.1^{\circ}\text{F}$ or $^{\circ}\text{C}$, over 1 year period (@ $T_{\text{amb}} = 23^{\circ}\text{C} \pm 5^{\circ}\text{C}$)

Sensing Element: Class A, 4 Wire RTD

Case Material: NEMA 4X 300 Series Stainless Housing

Probes: IP68 Remote Cable Connection System; 1/4", 3/8", or 1/2" Diameter, Tapered Bulb, Sanitary, Spring Loaded, Welded

Probe Connection: Rigid, Adjustable Angle, or Remote

Power: 24 VDC Loop Powered Local Display and 4-20 mA Transmitter

Display Resolution: 0.1°F or $^{\circ}\text{C}$. 1°F above 999.9°F

Accessories: DSTCAL Calibration Software, Battery Types, NIST Certifications, and Remote Mounting Bracket

Specifications subject to change without notice

DST400 Thermocouple Systems

for maximum flexibility, speed of response, extreme high and low temperature and ability to switch thermocouple type

C. Digi-Stem Thermometer Systems with Five Thermocouple Inputs

Model: DST400K **Model:** DST400J
Range: -40° to 2500°F (-40° to 1371°C) **Range:** -40° to 2192°F (-40° to 1200°C)

Model: DST400T **Model:** DST400E
Range: -40° to 752°F (-40° to 400°C) **Range:** -40° to 1832°F (-40° to 1000°C)

Model: DST400S
Range: -32° to 3200°F (0° to 1760°C)

Meter Accuracy: K, J, E Probes: < 1000 = ± 0.5°F, ± 0.3°C; > 1000 = ± 2 °F, ± 1°C;
T Probe: ± 0.5°F, ± 0.3°C; S Probe: Full Range = ± 2°F, ± 2°C

Sensing Element: 5 user specified thermocouple input types K, J, T, E, or S

Case Material: NEMA 4X 300 Series Stainless Housing

Probes: 304 or 316 Stainless Steel; 1/4", 3/8", and 1/2" Diameter, Tapered Bulb, Sanitary, Spring Loaded, Welded

Probe Connection: Rigid, Adjustable Angle, or Remote

Power: Battery Powered LCD Display with 1" Digits

Display Resolution: < 1000 = 0.1° ; > 1000 = 1°C

Accessories: DSTCAL Calibration Software, Battery Types, NIST Certifications, and Mounting Equipment

Select any or the 5 factory programmed Thermocouple inputs at time of purchase, and change to any of the other 4 inputs after purchase with our easy to use optional DSTCAL software.



D. Digi-Stem Thermocouple Thermometer & Transmitter System

Model: DSXA300 Meter with 4-20 mA Transmitters

Range: 0.0° to 300°F (-18° to 150°C)

Meter Accuracy: ± 1.1°F: 0° to 150°F; ± 2°F: 150° to 300°F; ± 0.7°C: -18° to 150°C

Sensing Element: Type K Thermocouple

Case Material: NEMA 4X 300 Series Stainless Housing

Probes: Immersion, Sanitary, Spring Loaded, Brazed, Welded

Probe Connection: Remote

Power: Loop Powered Local Display and 4-20 mA Transmitters

Display Resolution: 0.1°F: 0° to 150°F; 1°: 150° to 300°F; 0.1°C

Accessories: 24 VDC Loop Power: 12/42 V DC min/max; Loop Output: 4-20 mA; Fixed zero and span NIST, Range Expansion Options, Secondary Element Options, Cables, Batteries, Certifications, and Remote Mounting Brackets also available

NOTE ABOUT PURCHASING: Digi-Stem Probes are custom built to your specifications and must be ordered separately from the meter to compose a complete system.

Our variety of rigid, all angle stems and remote interface connections accommodate most installations.

Digi-Stem® is a registered trademark of Wahl Instruments, Inc.



Heat Prober® Hand Held RTD, TC & Thermistor Meters

High performance portable temperature
measurement systems



Wahl invented the portable Platinum RTD Thermometer

It provides exceptional accuracy and long term stability in a versatile meter system with interchangeable probes. Simply plug in and play! Verify the calibration of the meter before each use, or check multiple meters without the need to return each meter for NIST with the CAL392HP (Figure F). The simplest and easiest to use hand held meter and probe system on the market.



A. 392A High Performance Platinum RTD System

Model: 392AHPF	Model: 392AHPC	Model: 392AHPD Dual Scale Switchable
Range: -290° to 1450°F	Range: -180° to 788°C	Range: -290° to 1450°F (-180° to 788°C)
Sensing Element: RTD		
Probe: Interchangeable probes		
Probe Connection: Interchangeable, 4 wire plug in connection HP Series Probes		
Display: Bright 0.33" high visibility LED display, "X" Models - LCD		
Display Resolution: 0.1° below 375°F (190°C); Auto Ranges to 1° above 375°F (190°C)		
Meter Accuracy: ± 0.1°F/C ± 1 digit at 32°F (0°C) at 77°F		
Battery: 6.25 V rechargeable NiCad Battery		

B. 392A Series Platinum RTD Thermometer Systems

Model: 392AMF	Model: 392AMC	Model: 392AMD Dual Scale Switchable
Range: -60° to 752°F	Range: -51.1° to 400°C	Range: -60° to 752°F (51.1° to 400°C)
Sensing Element: RTD		
Probe: Interchangeable platinum probes		
Probe Connection: 3 wire plug in connection Probes		
Display: 392AM: Bright 0.33" high visibility LED display, 392AMX, 392AVX: 0.4" Red LCD display		
Display Resolution: 0.1° below 375°F (190°C); Auto Ranges to 1° above 375°F (190°C)		
Meter Accuracy: ± 0.1°F/C ± 1 digit at 32°F (0°C) at 77°F		
Battery: 6.25 V rechargeable Ni Cad Battery, 392AVX: 9V Alkaline Battery		

C. Thermocouple Meters

Model: 2500	Model: 1370	Model: TCMR-K °F/°C Switchable
Range: -100° to 2500°F	Range: -70° to 1370°C	Range: -100° to 2500°F (-70° to 1370°C)
Sensing Element: Type K Thermocouple, Type S available		
Display: LED, "X" Models - LCD		
Probe: All Type K probes		
Probe Connection: ANSI Mini-Connector		
Display Resolution: 1°		
Meter Accuracy: ± 0.2%, ± 1 digit		
Battery: 6.25 V rechargeable Ni Cad Battery. MV Models: 9V battery		

D. Thermistor Meters

Model: 700MC or 700MF
Range: -1.00° to 60.99°C or 30.20° to 141.78°F
Sensing Element: Thermistor
Probe: Interchangeable Thermistor Probes
Probe Connection: 1/4" Stereo Jack
Display: LED
Display Resolution: .01°C / °F
Meter Accuracy: ± 0.03°C (.06°F)
System Accuracy: ± 0.15°C (0.27°F) when meter and probe are calibrated separately or ± 0.04°C (0.7°F) when meter and probe are calibrated together



ALSO AVAILABLE

Immersion Probes

General Purpose, HVAC Test

Material: Stainless Steel Sheath, Delrin guard on HVAC Air-Gas Test Probe

Penetration Probes

Heavy Duty Piercing Probe, Needle Tip, Fine Tip, Sharp Tip, Hypodermic

Surface Probes

Straight or 45° Spring Articulated

Plug-Type Probes

Threaded Plug-Type

Material: 7/19" Hex Nut threaded to 3/8" - 24 NF with 4 ft. over braided cable

Ordering Note: A Heat-Prober "system" consists of a meter and a sensing probe. The Heat-Prober meter serves to accurately interpret the temperature sensed by the probe, provide digital display, and allow measurement options. The meter also contains the power (battery) to allow complete system portability.

Specifications subject to change without notice

E. TM Pocket Thermometers

Model: TM602

Sensing Element: Thermocouple

Probe Connection: 14 Thermocouples and 12 RTD types

Probe Connection: 4 pin round connector or 4 banana plugs, TM602 - mini T/C uncompensated connector

Probes: Thermocouple Types: K, T, J, E, R, S, B, U, L, C, N. RTD: Resistive Probes;

Pt 50, Pt 100, Pt 200, Pt 500, Pt 1000, Ni 100, Ni 120, Ni 1000, Cu 50

Display: Graphical LCD with adjustable contrast and backlight. Display in °C, °F, mV, and Ohm

Display Resolution: Programmable by user; Up to 1mΩ or 1μV

Meter Accuracy: 0.02% of Reading

Accessories: Rechargeable Batteries and Battery Charger, NIST Calibration Certificate, and Carrying Case

Model: TM612 (pictured)

Sensing Element: RTD

Model: TM630

Sensing Element: TC and RTD



ONE YEAR
1
WARRANTY



F. 5-Point NIST Traceable RTD Calibrators Assure laboratory accuracy in the field when used with 392A meters

NIST Certificate Included

High Temperature

Model: CAL392HP-HT (for High Temperature Calibrator for 392AHP only)

Model: CAL392-HT (for High Temperature Calibrator 392A)

Calibration Points: -58°F, 32°F, 212°F, 284°F, 752°F (-50°C, 0°C, 100°C, 140°C, 400°C)

Low Temperature

Model: CAL392HP-LT (for Low Temperature Calibrator for 392AHP only, Ice Point to Boil)

Model: CAL392-LT (for Low Temperature Calibrator 392A)

Calibration Points: 32°F, 68°F, 104°F, 140°F, 212°F (0°C, 20°C, 40°C, 60°C, 100°C)



G, H

G. Type S Dipstick Thermometer Systems, Ferrous Metal to 3200°F / 1770°C

Use in molten iron and steel alloys with or without slag for measuring melts in ladles and melt-pots. Stable readings are obtained in 6-8 seconds. Dipstick comes with one expendable tip. Spare tips are sold separately.

TC840-1F or C - 48" length dipstick with 45° angle bend

TC840-2F or C - 60" length dipstick with 45° angle bend

TC840-3F or C - 60" straight dipstick meter with RTC832 expendable tip

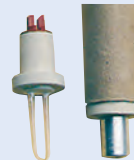

Expendable Type S Tips

RTC832 - Expendable Type S 1-3/4" quartz covered (exposed) tip for shallow dips.

RTC832S - Expendable Type S 1-3/4" quartz covered (exposed) tip with 12" cardboard sleeve for deeper dips.

H. Type K Dipstick Thermometer Systems, Nonferrous Metal to 2500°F / 1370°C

Rugged reusable chrome-tip with Type K thermocouple measures nonferrous metals such as brass, bronze and aluminum, and enclosures such as furnaces, stacks, and ovens. It can be used for hundreds of dips, depending on composition of process materials.

TC850-1F or C - 55" length dipstick with right angle

TC850-2F or C - 72" length dipstick with right angle

I. TM410 Thermocouple Food Service Thermometer

Range: -40° to 1999°F (-40° to 1092°C) Switchable

Meter Accuracy: ± 1.0°F (± 0.5°C) in an operating range of 32° to 200°F (0° to 93°C)

- Meets and exceeds FDA Requirements (Food Code requires ± 2°F)
- Optional probes plug into the top of TM410 for easy single-handed use (see pg 17 #Q for probe information)
- Optional TCL329K Extension Handle for extended reach (pictured at left)
- Built in pocket/belt clip on back of unit
- Reduced dirt-harboring crevices for easy cleaning
- 3 - AAA Batteries



Heat Prober® is a registered trademark of Wahl Instruments, Inc.

Heat Prober® Platinum RTD Probes

The most reliable standard for measuring and comparing temperature information.

392A Series Platinum RTD Probes

Platinum RTD Probes are recognized worldwide by metrology laboratories as the most reliable standard in temperature measurement. Our platinum sensors are housed in thin wall stainless steel shanks with low mass tips that don't compete with the measured object. Wahl probes have fast response, and provide long-term stability, repeatability, and an accuracy of $\pm 0.2^\circ\text{F}$ at ice point, $\pm 0.5\%$ of reading thereafter.

Every probe is engineered to do a specific job in measuring surfaces, liquids, semi-solids or gasses. Each probe has a high quality, heat resistant Delrin® handle, a coiled 5-foot cord and a snap-in connector that mates it solidly to our thermometer. Every probe is calibrated at two or three temperature points on NIST traceable secondary standards and tagged "Wahl Test Certified" with calibration data. You can order a NIST certificate with test data for meters and probes.

Wahl patented the First thermocouple surface probe in 1982 Our expertise enables us to design and build an interchangeable meter/probe system allowing for any number of probes for specific applications.



A. 112 Fine-Tip Penetration Probe for foods and other soft substances

B. 114 Heavy-Duty Piercing Probe for plastic melts, rubber, asphalt, frozen foods, or other semi-solids

C. 121 Spring Articulated Straight Surface Probe for molds, dies, platens, electronics, machine housings and all other surfaces

D. 123U Right Angle Fast Surface Probe for reaching into die and mold cavities, electronic chassis, or other restricted areas

E. RTD Sanitary Probe Single 4 wire or Dual 3 wire RTD Sensors, Available with 1.5", 2", 2.5", or 3" sanitary flange

F. 124 Rigid Shank Fast Surface Probe for rugged applications

G. 145 45° Spring Articulated Surface Probe for molds, dies, platens, electronics, and all other surfaces

H. 155 Bolt-on Surface Probe for permanent installation, used to monitor engine or reactor surface temperatures

I. 172 Self-Adhesive Surface Probe for monitoring environmental tests, curing cycles, and oven processing

J. 201 General Purpose Immersion Probe (not pictured) for liquids, foods, candy, granular materials, and semi-solids

K. 202 Sensitive Immersion Probe for use in all liquids and semi-solids

L. 392AHP Probe Connector 4 pin connector for 3-wire RTD and balancing resistor circuit

Note: Platinum RTD Probes may be used with the TM612 and TM630 Meters shown on pg 13. Add "TM" to end of model number when ordering.

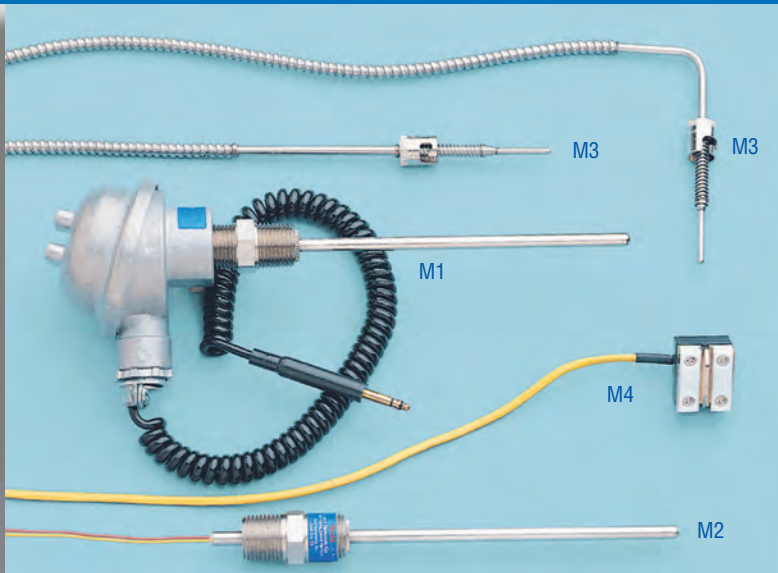

M. Specialty Probes

Wahl offers a variety of probes for immersion in liquids and semi-fluids, insertion, penetration, air and gas calibration, surface measurements, and other applications

M1. 292RTD Sealed Immersion Probe for installation in thermowells

M2. TC881 Spring-Loaded Thermowell Probe

M3. TC882 Spring-Loaded Type K TC Bayonet Probe

M4. TC886 Magnetic Surface TC Probe

N. 203 Teflon®-Coated Immersion Probe (not pictured) for use where corrosive solutions and possible metallic contamination are a concern

O. 204 12" Long-Reach Immersion Probe (not pictured) for baths, vats, kettles and other deep vessels

P. 204CT Paddle Probe for crystallization and fluid temperatures while agitating liquids

Q. 205 Heavy-Duty Immersion Probe for solder baths, liquids, granular materials, and gas

R. 205SH Heavy-Duty Shielded Immersion Probe shield protects the tip from the shock of hitting vat or container walls, and from mixer blades

S. 212 Fully Immersible Probe with no handle for plating baths, dipping solutions, brewing vats, storage vats, tanks, rivers and streams

T. 302 Air/Gas Probe with perforated sensor shield to protect open element sensor from particulates and direct surface contact, used in industrial application such as ovens, stacks and ducts

U. 305 Miniature Air/Gas Probe (not pictured) perforated steel tube for fast response HVAC applications

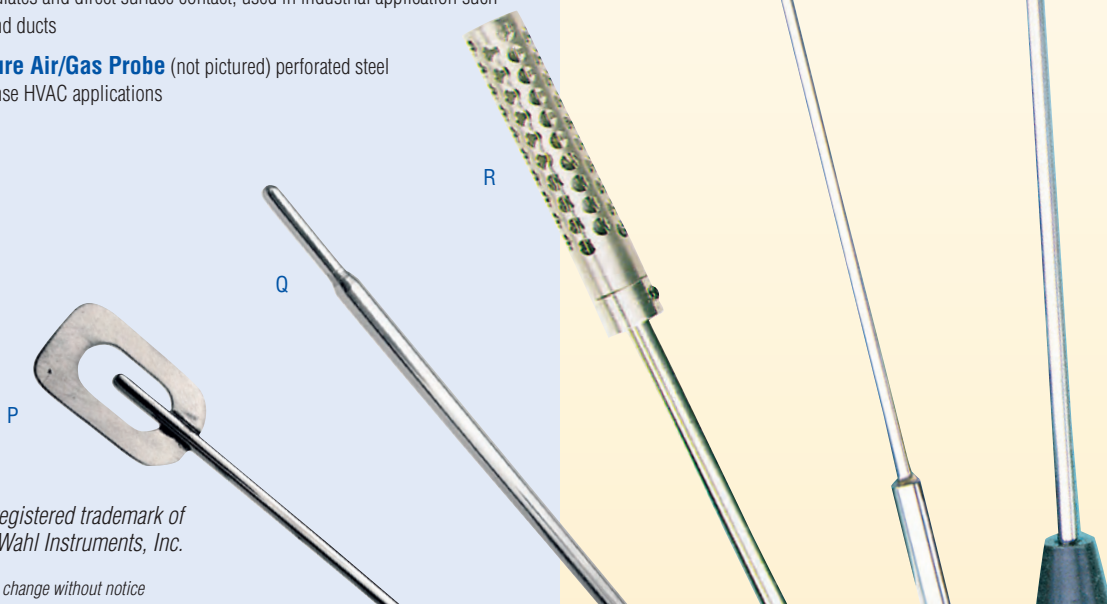

Heat Prober® is a registered trademark of Wahl Instruments, Inc.

Specifications subject to change without notice

Special Request & Build to Order Probes with Wahl's Custom Engineering Service

If you have a unique requirement for temperature probes, Wahl will custom-engineer and build them for you. We have produced more than 2000 custom designs. It's simple: send us a sketch or digital drawing of dimensional requirements, environmental conditions, temperature limits, accuracy, output (TC or RTD) and quantity. We will promptly return an engineered design and price quotation. In addition to the thermocouple and platinum-RTD probes shown throughout, Wahl offers off-the-shelf probes for immersion in liquids and semi-fluids, insertion, penetration, air and gas calibration, surface measurements, and other applications.

Wahl Platinum RTD probes are interchangeable without Recalibration!

Only Wahl offers an interchangeable probe system that assures consistent accuracy and 0.2°F repeatability without meter recalibration.

Infrared

Digi-Stem

Hand Held Meters

Sensors

Temp-Plates

Thermometers

Thermowells

Recorders

Pressure Gauges

Calibration

Heat Prober® Thermocouple Probes

Thermocouple and Thermistor Sensors

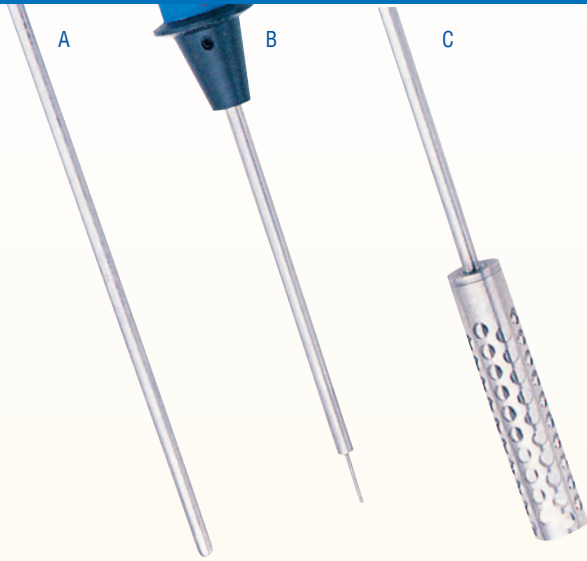

Thermocouple portable temperature sensors have the advantage over other types due to their fast response, wide temperature range, and ruggedness. The sensors are small in size, versatile and convenient to use. An added advantage of thermocouple use is derived from their wide-spread availability and meter/probe compatibility.

Thermistor sensors offer excellent accuracy and long-term stability, but over a relatively narrow temperature range. Thermistors are generally used to measure moderate temperatures in applications demanding greater accuracy than thermocouples, but less demanding than Platinum RTD Thermometer Systems.



Type K Thermocouple Probes

Wahl thermocouple probes are designed for the fastest response possible depending upon use. Each starts with the thermocouple junction, precision welded for virtually instant response. Then a stainless steel sheath is created with a thin wall for fast measurements or a thicker wall for heavy duty applications. Surface probe tips are Wahl-engineered to provide optimum contact with the least thermal load.

- A. TC801 Immersion Probe** for fluids, corrosive mixtures, solder baths and viscous materials
- B. TC803 Electronics Tip Probe** for electronic and biological applications
- C. TC805 Air/Gas Probe** for fast response and good accuracy in high temperature radiation backgrounds
- D. TC809H Heavy-Duty Surface Probe System** for surface temperature measurement of ingots, furnaces, kilns, molds and platens, use replaceable tips E, F, and G.
- E. TC821H Heavy Duty Surface Probe Tip** 45° tip
- F. TC821R Heavy Duty Surface Probe Tip** 90° tip
- G. TC821S Heavy Duty Surface Probe Tip** straight tip
- H. TC812K Magnetic Surface Probe** with 3 lb. pull magnet attaches easily to ferrous surfaces
- I. TC813 Bolt-On Surface Probe** for continuous monitoring, withstands hazardous environments
- J. TC814 Hypodermic Probe** for minimal disruption when inserted into semi-solids
- K. TC817 Heavy-Duty Piercing Probe** for plastic melts, rubber, asphalt, frozen foods, or other semi-solids
- L. TC861 Pencil-Type Electronic Tip Probe** for electronic component testing
- M. TC867 Soldering Iron Tester Probe** (not pictured) instant checking of iron for critical operations
- N. TC869 45° Spring Articulated Surface Probe** provides certain surface contact for platens, hot plates, molds
- O. TC871 Threaded Plug-Type Probe** for shell cavities and machinery walls
- P. TC873 Right Angle Surface Probe** flexible bands for rolls, curved surfaces, platens, and, molds



Look for the "Wahl Tested Certified" calibration tag on every probe



Q. Economy Type K Thermocouple Direct Connect to Meter Probes

- TP-100 Needle-Tip Penetration Probe 4" shank, direct connect to meter
- TP-101 Fine-Tip Penetration Probe 4" shank, direct connect to meter
- TP-102 Sharp-Tip Penetration Probe 6" shank, direct connect to meter
- TP-200 General-Purpose Immersion Probe 8" shank, direct connect to meter
- TP-300 Alligator Clip-on Oven/Air Probe 4 ft length, high temperature insulated connector cable

R. TCL329 Economy Type K and J Thermocouple Probe Extension Handle

For routine maintenance and testing applications. TCL329 Extension Handle allows use of interchangeable, "direct to meter" probes with one handle and cord set. This economical and compact Type K probe system is usable with any Wahl Thermocouple Meter. 4" Handle accepts all ANSI mini-connector type J or K probes. 5 ft coiled lead connects to meter. Probes listed below are not pictured.

- TCL301J/K* General Purpose Probe with Delrin handle, 8" shank with .125" diameter
 - TCL309J/K* Handle and Probe Set. TCL329 Handle with TCL383 Immersion probe
 - TCL329J/K* Handy Extension Handle for use with direct connect probes.
 - TCL363J/K* Unmounted 3 ft Bare Thermocouple, exposed junction
 - TCL383J/K* Immersion Probe 8" shank with .125" diameter, direct connect to meter
- * Specify J or K type thermocouple at end of model number

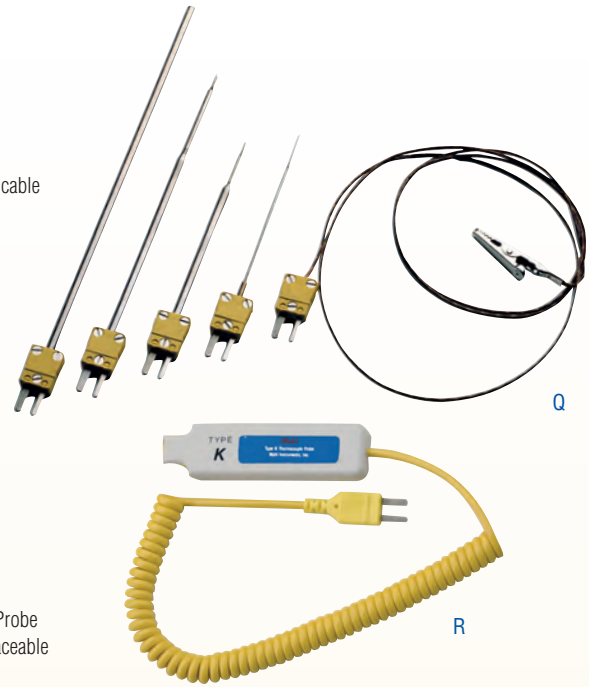

S. TC829 Type K Thermocouple Probe Extension Handle System

TC829 extension handles are designed for rugged, long-reach applications. The TC829 Handle/Probe System is compatible with any Wahl Thermocouple Heat-Prober Meter. Screw on any of the replaceable RTC Series probes and go to work with confidence. Available in 12", 24", 36", or 48" lengths.

T. Type K Thermocouple Probe Systems

- T1. RTC827A Heavy Duty Ingot Probe
- T2. RTC825 Heavy-Duty Curved Surface Band Probe
- T3. RTC823 Spring-Loaded Z-Tip Surface Probe
- T4. RTC822L Heavy-duty Z-Tip Fast Response Surface Probe
- T5. RTC822 Z-Tip Fast Response Surface Probe
- T6. RTC824 Roll Surface Probe
- T7. RTC826 Penetration Probe
- T8. RTC827 Ingot Probe
- T9. RTC828 (not pictured) Immersion Probe
- T10. RTC877 (not pictured) Moving Surface Probe



U. PTK T-Handle Piercing Probe

304 Stainless Steel, 8" Shank length equipped with mini-T/C female connector and Single or Dual Sensor Type K Thermocouple Probe for a wide range of applications such as canning and meat processing.

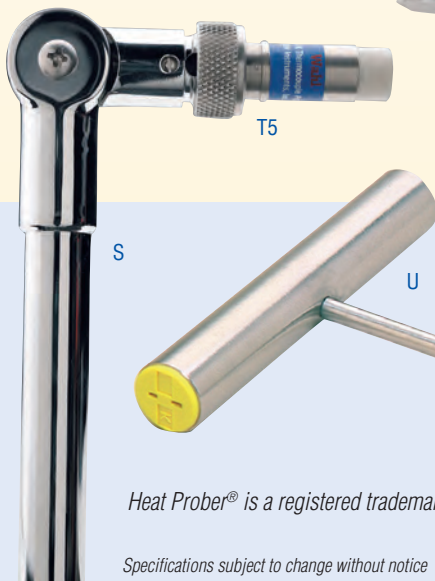
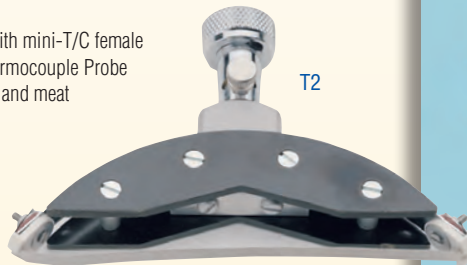

Heat Prober® is a registered trademark of Wahl Instruments, Inc.

Specifications subject to change without notice

Infrared

Digi-Stem

Hand Held Meters

Sensors

Temp-Plates

Thermometers

Thermowells

Recorders

Pressure Gauges

Calibration

TC & RTD Sensor Assemblies

Precise temperature measuring sensors

TC & RTD Sensors are engineered for quality and reliability

Wahl Thermocouples and RTD's are precise temperature measuring sensors engineered to provide the highest quality and reliability. You can configure these RTD and Thermocouple systems and components to fit most industrial applications.

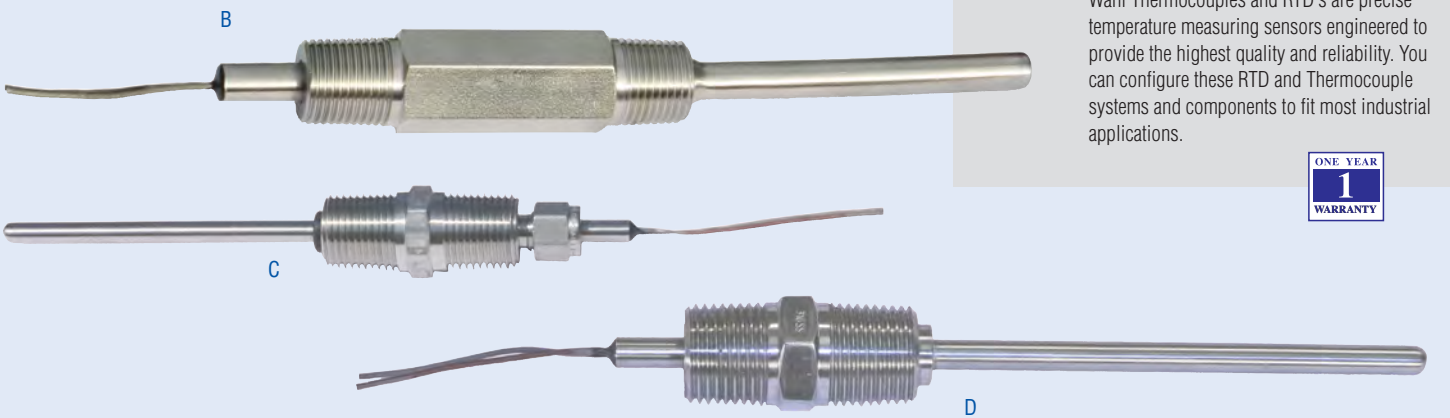

A. Standard Welded Probe - 304SS

RTD Series: WR1 Series

Sensing Element: RTD, Pt 100 IEC 751 (385 DIN)

Probe Material: 304SS

Probe Connection: Standard Nipple, Lagging Extension

Range: -50° to 400°F, (-45° to 204°C)

Stem Diameter: 1/4" or 3/8"; 2, 3, or 4 wire configurations

Stem Length: 1 to 72 inches in 1/4" increments

Options: Thin Film or Wire Wound RTD Types

T/C Series: WT1 Series

Sensing Element: Thermocouple, Types K, J or T

Probe Material: 304SS

Probe Connection: Standard Nipple, Lagging Extension

Range: Type K: -40° to 1000°C, or -40° to 1832°F

Stem Diameter: 1/8", 1/4", or 3/8"

Stem Length: 1 to 72 inches in 1/4" increments

Options: Grounded or Ungrounded

B. Standard Welded Probe - 316SS

RTD Series: WR2 Series

Sensing Element: RTD, Pt 100 IEC 751 (385 DIN)

Probe Material: 316SS

Probe Connection: Standard Nipple, Lagging Extension

Range: -50° to 400°F, (-45° to 204°C)

Stem Diameter: 1/4" or 3/8"; 2, 3, or 4 wire configurations

Stem Length: 1 to 72 inches in 1/4" increments

Options: Thin Film or Wire Wound RTD Types

T/C Series: WT2 Series

Sensing Element: Thermocouple, Types K, J or T

Probe Material: 316SS

Probe Connection: Standard Nipple, Lagging Extension

Range: Type K: -40° to 1000°C, or -40° to 1832°F

Stem Diameter: 1/8", 1/4", or 3/8"

Stem Length: 1 to 72 inches in 1/4" increments

Options: Grounded or Ungrounded

C. Compression Fitting Probe - 304SS

RTD Series: WR3 Series

Sensing Element: RTD, Pt100 IEC 751 (385 DIN)

Probe Material: 304SS

Probe Connection: Standard Nipple, Lagging Extension

Range: -50° to 400°F, (-45° to 204°C)

Stem Diameter: 1/4" or 3/8"; 2, 3, or 4 wire configurations

Stem Length: 1 to 72 inches in 1/4" increments

Options: Thin Film or Wire Wound RTD Types

T/C Series: WT3 Series

Sensing Element: Thermocouple, Types K, J or T

Probe Material: 304SS

Probe Connection: Standard Nipple, Lagging Extension

Range: Type K: -40° to 1000°C, or -40° to 1832°F

Stem Diameter: 1/8", 1/4", or 3/8"

Stem Length: 1 to 72 inches in 1/4" increments

Options: Grounded or Ungrounded

D. Spring Loaded Probe - 316SS

RTD Series: WR4 Series

Sensing Element: RTD, Pt 100 IEC 751 (385 DIN)

Probe Material: 316SS

Probe Connection: Standard Nipple Only

Range: -50° to 400°F, (-45°C to 204°C)

Stem Diameter: 1/4"; 2, 3, or 4 wire configurations

Stem Length: 1 to 72 inches in 1/4" increments

Options: Thin Film or Wire Wound RTD Types

T/C Series: WT4

Sensing Element: Thermocouple, Types K, J or T

Probe Material: 316SS

Probe Connection: Standard Nipple Only

Range: Type K: -40° to 1000°C, or -40° to 1832°F

Stem Diameter: 1/4"

Stem Length: 1 to 72 inches in 1/4" increments

Options: Grounded or Ungrounded

E. Sanitary Probe - 316SS

RTD Series: WR5 Series

Sensing Element: RTD, Pt 100 IEC 751 (385 DIN)

Probe Material: 316SS

Probe Connection: 1.5", 2.0", 2.5", and 3" flange

Range: -50° to 400°F, (-45° to 204°C)

Stem Diameter: 1/4" or 3/8"; 2, 3, or 4 wire configurations

Stem Length: 1 to 72 inches in 1/4" increments

Options: Thin Film or Wire Wound RTD Types

T/C Series: WT5 Series

Sensing Element: Thermocouple, Types K, J or T

Probe Material: 316SS

Probe Connection: 1.5", 2.0", 2.5", and 3"

Range: Type K: -40° to 204°C, (-40° to 400°F)

Stem Diameter: 1/4"

Stem Length: 1 to 72 inches in 1/4" increments

Options: Grounded or Ungrounded

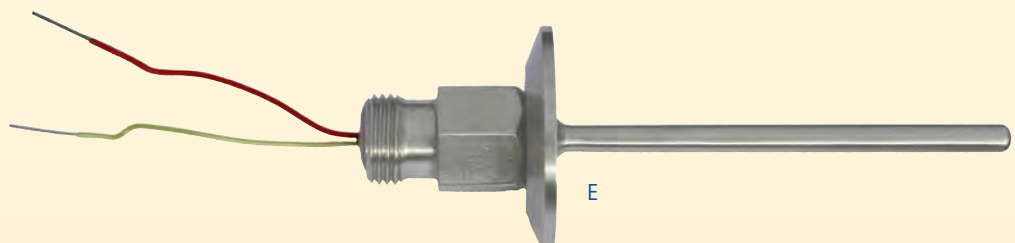

Specifications subject to change without notice

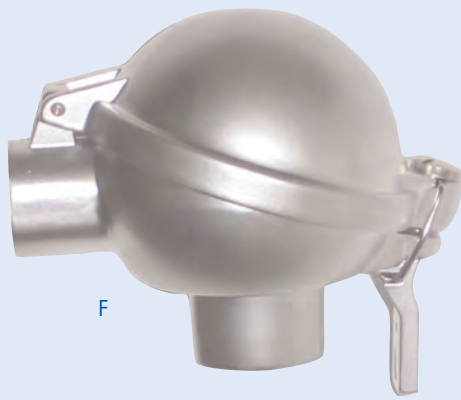

F



G



H



I



J



L



K

F. General Purpose Aluminum Flip-Top Heads

Case Material: Aluminum, Baked enamel silver paint and corrosive resistant hardware

Process Connection: 1/2" NPT

Conduit Connection: 1/2" NPT or 3/4" NPT

Ratings: IP68

G. General Purpose Aluminum Screw-Top Heads

Case Material: Aluminum, Epoxy painted for NEMA protection

Process Connection: 1/2" NPT

Conduit Connection: 1/2" NPT or 3/4" NPT

Ratings: NEMA 4X and IP68

Options: Unpainted finish available

H. General Purpose Stainless Steel Screw-Top Heads

Case Material: 316 Stainless Steel

Process Connection: 1/2" NPT

Conduit Connection: 3/4" NPT

Ratings: NEMA 4X

I. General Purpose Cast Iron Screw-Top Heads

Case Material: Hi-Temp Black Painted Cast Iron

Process Connection: 1/2" NPT

Conduit Connection: 1/2" NPT or 3/4" NPT

Ratings: NEMA 4X

J. General Purpose Polypropylene Screw-Top Heads

Case Material: White Polypropylene

Process Connection: 1/2" NPT

Conduit Connection: 3/4" NPT

Ratings: FDA approved polypropylene

K. Explosion Proof 316SS & Cast Aluminum Screw-Top Heads

Case Material: 316SS or cast aluminum, stainless steel chain and screws

Process Connection: 1/2" NPT

Conduit Connection: 1/2" NPT or 3/4" NPT

Ratings: NEMA 4X

Options: Explosion proof: Class 1, Div. 1, Groups A, B, C, and D; Dust-ignition proof for Class II, III, Division 1, Groups E, F, and G; Hazardous Classified Locations; Indoor / Outdoor

L. Stainless Steel Sanitary Flip-Top Heads

Case Material: 316SS

Process Connection: 1/2" NPT

Conduit Connection: 1/2" NPT or 3/4" NPT

Ratings: NEMA 4X, 3A

Wahl offers In-Head transmitters including universal, programmable, and fully HART compatible models. See Sensors catalog for more information.

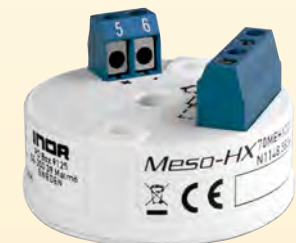

Temp-Plate® Temperature Sensitive Labels

The World's Smallest Temperature Recorder
NIST Traceable with a wide variety of applications

Irreversible Temperature Labels

Description: Mylar (clear) for ranges: 90° to 350°F (32° to 176°C)
Kapton (amber) for ranges: 350° to 500°F (176° to 260°C)

A. STANDARD Four-Position - 240

Number of Positions: 4 **Base Part Number:** 240
Size: .75" x 1.75" **Description:** Available in Mylar or Kapton

B. MINI Four-Position - 101-4

Number of Positions: 4 **Base Part Number:** 101-4
Size: .38" x .82" **Description:** Available in Mylar or Kapton

C. MINI Four-Position ROUND - 444

Number of Positions: 4 **Base Part Number:** 444
Size: .56" Diameter **Description:** Available in Mylar only

D. MICRO Four-Position - 441

Number of Positions: 4 **Base Part Number:** 441
Size: .13" x .44" **Description:** Available in Mylar or Kapton

E. MICRO Four-Position, Round - 442

Number of Positions: 4 **Base Part Number:** 442
Size: .25" Diameter **Description:** Available in Mylar only

F. Unmarked MICRO Four-Position, Round - 440

Number of Positions: 4 **Base Part Number:** 440
Size: .25" Diameter **Description:** Available in Mylar only

G. MINI Eight-Position - 101-8

Number of Positions: 8 **Base Part Number:** 101-8
Size: .38" x 1.5" **Description:** Available in Mylar or Kapton

H. MINI Six-Position - 101-6

Number of Positions: 6 **Base Part Number:** 101-6
Size: .38" x 1.16" **Description:** Available in Mylar or Kapton

I. MICRO Three-Position - 430

Number of Positions: 3 **Base Part Number:** 430
Size: .13" x .30" **Description:** Available in Mylar Only

J. MINI Single-Position Round - 414

Number of Positions: 1 **Base Part Number:** 414
Size: .56" Diameter **Description:** Available in Mylar or Kapton, printed °F and °C

K. MINI Single-Position Square - 210

Number of Positions: 1 **Base Part Number:** 210
Size: 1" x .75" **Description:** Available in Mylar or Kapton, printed °F or °C

*Calibrated to ±1% NIST traceable
accuracy from 90°F to 500°F
(32°C to 260°C)*

Temp-Plates® are self adhesive temperature recording labels that can be read at a glance. Rated temperatures are printed at the sensor window. Each Temp-Plate contains one to several sealed heat-sensitive elements which change chemical structure when exposed to heat exceeding their calibrated temperatures. Where exacting temperature is critical, a Temp-Plate's miniaturized size permits installation on parts and in areas where other recording instruments prove impractical.

Irreversible Color Change from pearl gray to black at 1% of indicated value of rated temperatures.

Pressure sensitive adhesive backing rated to 500°F on smooth, clean, dry surfaces. Wahl Temp-Plates are the only NIST traceable labels on the market.

Wahl developed and patented the First miniature temperature recording labels in 1960



A

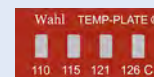

B

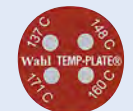

C



G



H



I



J

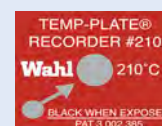

K



D



E



F



Temp-Plates are shown actual size

Specifications subject to change without notice

Instant Overheat Detector!

Possible Temperatures			
Fahrenheit	Celsius	Fahrenheit	Celsius
90	32	280	138
95	35	290	143
100	38	300	149
105	41	310	154
110	43	320	160
115	46	330	166
120	49	340	171
130	54	350	177
140	60	360	182
150	66	370	188
160	71	380	193
170	77	390	199
180	82	400	204
190	88	410	210
200	93	420	216
210	99	435	224
220	104	450	232
230	110	465	241
240	116	480	249
250	121	490	254
260	127	500	260
270	132		

Cover material: Mylar (clear) 100° to 350°F, 38° to 176°C
Kapton: (amber) 350° to 500°F, 176° to 260°C

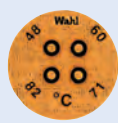

L



M

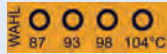

N



O

L. MINI Four-Position Round - 443

Number of Positions: 4

Base Part Number: 443

Size: .56"

Description: Kapton only for IC Batch and Vacuum Chamber

M. MINI Four-Position - 101-4

Number of Positions: 4

Base Part Number: 101-4

Size: .38" x .82"

Description: Kapton only for IC Batch and Vacuum Chamber

N. MICRO Four-Position - 450

Number of Positions: 4

Base Part Number: 450

Size: .20" x .65"

Description: Kapton only for IC Batch and Vacuum Chamber

O. Wahl Breaker - WB130

Number of Positions: 1

Base Part Number: WB130

Size: .47" x .47"

Description: Printed 130°F and 54°C

P. HOT HANDS Reversible Temperature Labels - 11895-1

Industrial Safety Labels - prevent skin burns

Number of Positions: 1 - 122°F

Base Part Number: 11895-1

Size: 1.5" Diameter

Description: hand turns bright red which says "HOT" when 122°F is reached

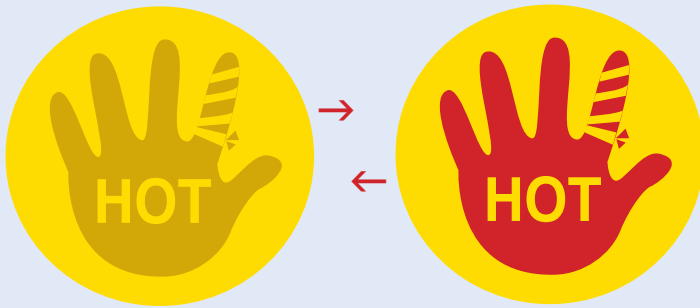

P

Custom Temp-Plates®

In addition to the wide selection of off-the shelf Temp-Plates, Wahl's engineering, graphics design and manufacturing experience invites OEM and end-users to solve their unique temperature recording requirements. We have successfully created custom and made-to-order Temp-Plates in partnership with a wide variety of manufacturing, design, maintenance and research industry leaders, including commercial and aviation, aerospace, energy, medical, pharmaceutical, and the computer industry.

www.wahltempplates.com

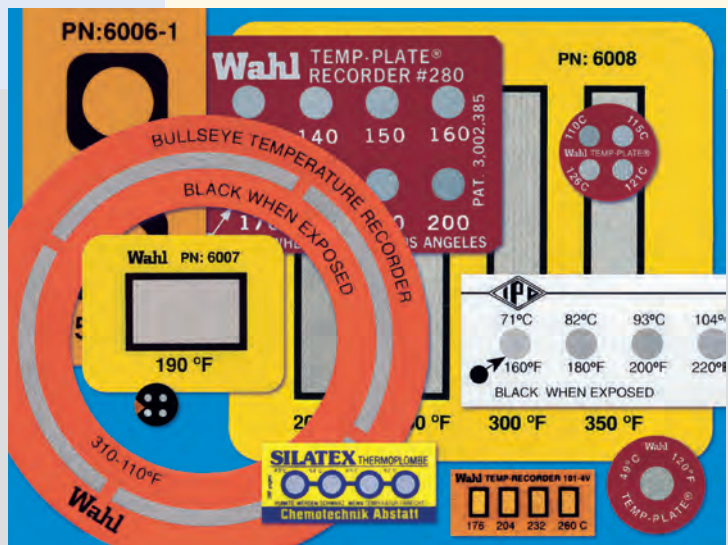

Temp-Plate® is a registered trademark of Wahl Instruments, Inc.

Bimetal Thermometers

Palmer design, quality, & craftsmanship make Palmer Bimetal Thermometers an industry standard for rugged reliability & accuracy

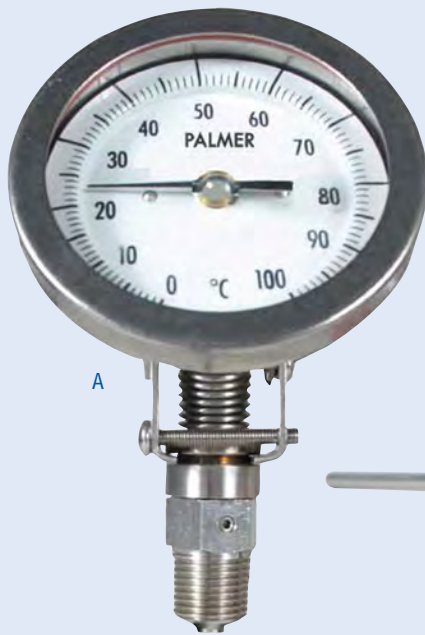

A



B



C

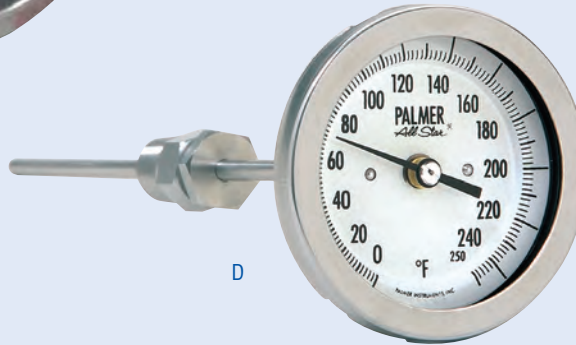

D



G

NEW! 316SS Bimetal

Palmer All-Star Bimetals are now available in 316SS for use in corrosive environments. IP67 Rated

A. Universal Mount - All Angle

Model: 3AU - 3" Case, 5AU - 5" Case
Case/Form: All Angle
Ranges: -100° to 1000°F or -50° to 500°C
Stem Length: Standard lengths to 24", optional up to 60"

B. All Star - Back Connected

Model: 3BC - 3" Case, 5BC - 5" Case
Case/Form: 304SS/316SS Back Connected
Accuracy: 1% of Full Range
Range: -100° to 1000°F or -50° to 500°C and Dual Range Scales
Recalibration: External Reset Nut. Dial rotation gear positions the Dial in relation to the Pointer
Stem Length: Standard lengths to 24", optional up to 60"

C. All Star - All Angle

Model: 3A - 3" Case, 5A - 5" Case
Case/Form: 304SS/316SS All Angle
Accuracy: 1% of Full Range
Range: -100° to 1000°F or -50° to 500°C and Dual Range Scales
Recalibration: External Reset Nut. Dial rotation gear positions the Dial in relation to the Pointer
Stem Length: Standard lengths to 24", optional up to 60"

D. All Star - Back Connected Adjustable Union

Model: 3BCJ - 3" Case, 5BCJ - 5" Case
Case/Form: 304SS/316SS Back Connected, Adjustable Union
Accuracy: 1% of Full Range
Range: -100° to 1000°F or -50° to 500°C and Dual Range Scales
Recalibration: External Reset Nut. Dial rotation gear positions the Dial in relation to the Pointer
Stem Length: Standard lengths to 24", optional up to 60"

E. All Star - All Angle Adjustable Union (not pictured)

Model: 3AJ - 3" Case, 5AJ - 5" Case
Case/Form: 304SS/316SS All Angle, Adjustable Union
Accuracy: 1% of Full Range
Range: -100° to 1000°F or -50° to 500°C and Dual Range Scales
Recalibration: External Reset Nut. Dial rotation gear positions the Dial in relation to the Pointer
Stem Length: Standard lengths to 24", optional up to 60"

F. All Pro - Back Connected (not pictured)

Model: 3BCP - 3" Case, 5BCP - 5" Case
Case/Form: 304SS Back Connected
Accuracy: 1% of Full Range
Range: -100° to 1000°F or -100° to 1000°F and -70° to 540°C
Dual Range Scales
Recalibration: External Recalibration mechanism
Stem Length: 2.5", 4", 6", 9", 12", 15", 18", 24"

G. All Pro - All Angle

Model: 3AP - 3" Case, 5AP - 5" Case
Case/Form: 304SS All Angle
Accuracy: 1% of Full Range
Range: -100° to 1000°F or -100° to 1000°F and -70° to 540°C
Dual Range Scales
Recalibration: External Recalibration mechanism
Stem Length: 2.5", 4", 6", 9", 12", 15", 18", 24"

H. Replaceable Element - Back Connected

Model: 3BE - 3" Case, 5BE - 5" Case
Case/Form: 304SS Back Connected
Accuracy: 1% of Full Range
Range: -100° to 1000°F or -50° to 500°C
Recalibration: Micro-adjustable Pointer
Stem Length: Standard lengths to 24", optional up to 60"

Specifications subject to change without notice

Custom Dial Faces Available

Need a special dial face or scale for your project?

Palmer Wahl can custom design a dial face with virtually any design you can think of. Contact us at sales@palmerwahl.com to find out more.

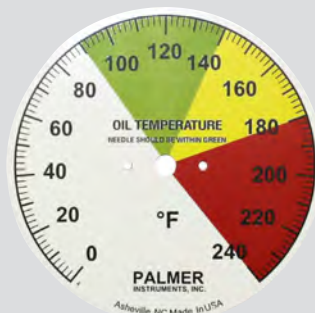

The First Replaceable Element Thermometer was developed by Palmer in 1973

Replacement operations are more efficient and cost effective. Leave the case in place and remove and refit the factory-calibrated internal parts only. As easy as replacing batteries in a flashlight! No replacement of case, and no process shut down.



The Slip-Fit Bimetal Thermometer was introduced by Palmer in 1992, allowing interchangeability in same thermowell as MIG's



K, M

O



L

The First Sanitary Bimetal Thermometer was introduced by Palmer in 1992 - no thermowell required

I. Replaceable Element - All Angle

Model: 3AE - 3" Case, 5AE - 5" Case
Case/Form: 304SS All Angle
Accuracy: 1% of Full Range
Range: -100° to 1000°F or -50° to 500°C
Recalibration: Micro-adjustable Pointer
Stem Length: Standard lengths to 24", optional up to 60"

J. Slip-Fit - Back Connected - Replaceable Element (not pictured)

Model: 3BIE - 3" Case, 5BIE - 5" Case
Case/Form: 304SS Back Connected
Accuracy: 1% of Full Range
Range: -100° to 1000°F or -50° to 500°C
Recalibration: External Reset Nut
Stem Length: 3.5", 6", 8", 9", 12", 15", 18", 24", 30", 36"

K. Slip-Fit - All Angle - Replaceable Element

Model: 3AIE - 3" Case, 5AIE - 5" Case
Case/Form: 304SS All Angle
Accuracy: 1% of Full Range
Range: -100° to 1000°F or -50° to 500°C
Recalibration: External Reset Nut
Stem Length: 3.5", 6", 8", 9", 12", 15", 18", 24", 30", 36"

L. Slip-Fit - External Reset Gear - Back Connected

Model: 3BI - 3" Case, 5BI - 5" Case
Case/Form: 304SS Back Connected
Accuracy: 1% of Full Range
Range: -100° to 1000°F or -50° to 500°C
Recalibration: External Reset Nut
Stem Length: 3.5", 6", 8", 9", 12", 15", 18", 24", 30", 36"

M. Slip-Fit - External Reset Gear - All Angle

Model: 3AI - 3" Case, 5AI - 5" Case
Case/Form: 304SS All Angle
Accuracy: 1% of Full Range
Range: -100° to 1000°F or -50° to 500°C
Recalibration: External Reset Nut
Stem Length: 3.5", 6", 8", 9", 12", 15", 18", 24", 30", 36"

N. Sanitary Bimetal - Back Connected (not pictured)

Model: 3BES - 3" Case, 5BES - 5" Case
Case/Form: 304SS Back Connected
Accuracy: 1% of Full Range
Range: -40° to 400°F or -50° to 200°C
Recalibration: Micro-adjustable Pointer
Stem Length: 2.5", 4.5"
Connection: 1-1/2", 2", or 3" Tri-Clamp Sanitary

O. Sanitary Bimetal - All Angle

Model: 3AES - 3" Case, 5AES - 5" Case
Case/Form: 304SS All Angle
Accuracy: 1% of Full Range
Range: -40° to 400°F or -50° to 200°C
Recalibration: Micro-adjustable Pointer
Stem Length: 2.5", 4.5"
Connection: 1-1/2", 2", or 3" Tri-Clamp Sanitary



Rigid & Remote Filled System Dial Thermometers

Versatile and dependable Palmer Direct-Drive Double Wound Temperature coil for accuracy and toughness in vibration applications

A. Rigid Dial Thermometers with 1-1/4"-18 Swivel Nut Fitting & Tapered Bulb

Model: 35A, 35AL - 3.5" Case, 50A, 50AL - 5" Case

Ranges: -100° to 1200°F or -60° to 500°C

Connection: 1-1/4" UNEF - 18 Swivel Nut, Optional 7/8"-22 Swivel Nut

Accuracy: ± 1 Scale Division

Calibration: External Reset Calibration Screw on back of case

Fill: Liquid or Mercury Actuated; Mercury over 500°F

Stem Length: 3.5" to 72"

Option: RTD or Thermocouple electronic sensors. 2, 3, 4-wire, 385 DIN/IEC751 Pt 100 RTD, or Type J or K Thermocouple.

B. Storage Tank Thermometers (not pictured)

Model: 35H - 3.5" Case, 50H - 5" Case

Ranges: -100° to 1200°F or -60° to 500°C

Connection: 1-1/4" UNEF-18 Swivel Nut. Optional 3/4" or 1" NPT Brass Union

Accuracy: ± 1 Scale Division

Calibration: External Reset Calibration Screw on back of case

Fill: Mercury Actuated (Capillary lengths up to 250 ft); Liquid Actuated (limited to Capillary lengths up to 15 ft and Temperature range of 500°F)

Capillary: 5 ft. of 3/16" diameter bendable stainless steel armor and bulb. Lengths longer than 5 ft. are optional

C. Rigid Dial Thermometers with 1/2" NPT & 1/4" Diameter Stem

Model: 1035 - 3.5" Case, 1050 - 5" Case

Ranges: -100° to 1200°F or -60° to 500°C

Connection: 1/2" NPT, Optional 7/8"-22 Swivel Nut or 316SS

Accuracy: ± 1 Scale Division

Calibration: External Reset Calibration Screw on back of case

Fill: Liquid or Mercury Actuated; Mercury over 500°F

Stem Length: 4" to 72"

D. Remote Reading Dial Thermometers Wall Mount

Model: 35B - 3.5" Case, 50B - 5" Case

Ranges: -100° to 1200°F or -60° to 500°C

Accuracy: ± 1 Scale Division

Calibration: External Reset Calibration Screw on back of case

Fill: Liquid or Mercury Actuated; Mercury over 500°F

Capillary: 5 ft of 1/2" Stainless Steel Capillary protected by a 1/4" diameter Flexible Armor; Optional Capillary materials available

E. Remote Reading Dial Thermometers Flush Mount

Model: 35C - 3.5" Case, 50C - 5" Case

Ranges: -100° to 1200°F or -60° to 500°C

Accuracy: ± 1 Scale Division

Calibration: External Reset Calibration Screw on back of case,

Fill: Liquid or Mercury Actuated; Mercury over 500°F

Capillary: 5 ft of 1/2" Stainless Steel Capillary protected by a 1/4" diameter Flexible Armor; Optional Capillary materials available

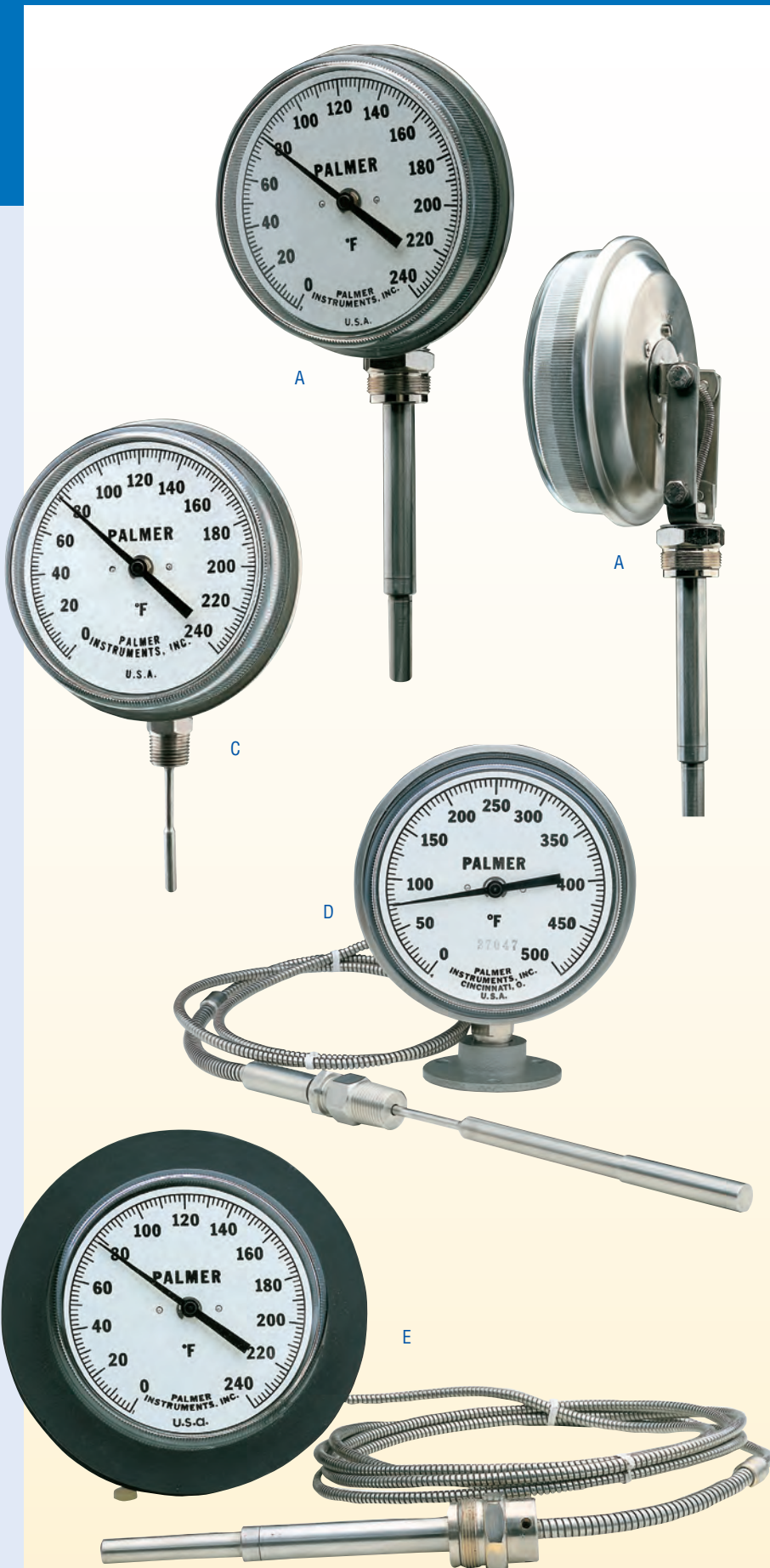

Specifications subject to change without notice

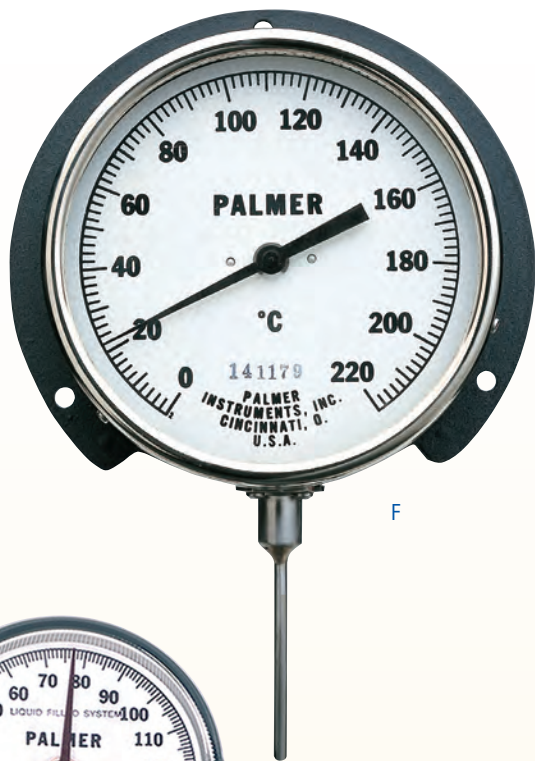

F

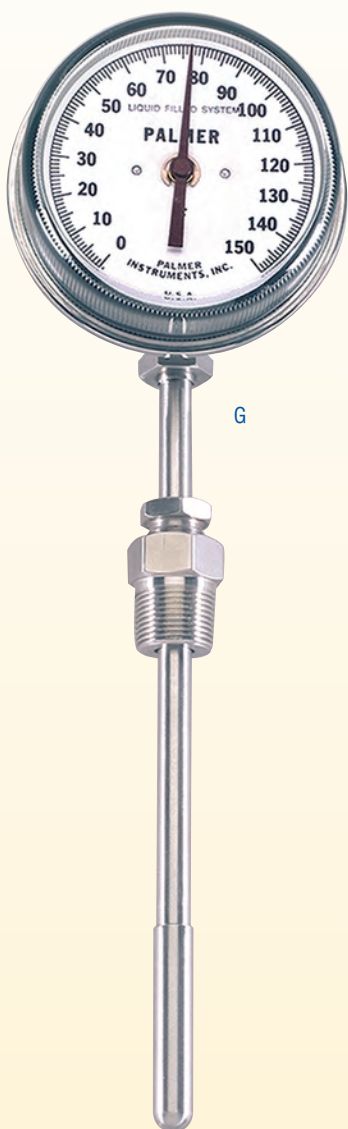

G



Palmer developed the First direct drive double wound coil for dial thermometers in the U.S.

Since the 1950's our unique bourdon coil, connected directly to the pointer shaft, has provided uncompromising accuracy in dial thermometers. Our filled system expertise has been incorporated into an extremely dependable thermal system, used in many different applications, including power plants and piping, chemical processing plants, breweries, canneries, heating and cooling equipment. All of Palmer's products have been engineered to provide the long service life and ease of adjustment you've come to expect. Palmer's Rigid and Remote Direct-Drive Dial Thermometers are proudly made in our Asheville, North Carolina plant.

F. Remote Reading Dial Thermometers Wall or Flush Mount

Model: 60B, 60C - 6" Case

Ranges: -100° to 1200°F or -60° to 500°C

Accuracy: ± 1 Scale Division

Calibration: External Reset Calibration Screw on back of case

Fill: Liquid or Mercury Actuated; Mercury over 500°F

Capillary: Stainless Steel Capillary protected by a 1/4" diameter Flexible Stainless Steel Armor

G. Rigid Dial Adjustable Union with 1/2" NPT SS Adjustable Union & 3/8" Diameter Stem

Model: 935 - 3.5" Case, 5" 950 Case

Ranges: -100° to 1200°F or -60° to 500°C

Connection: 1/2" NPT SS Adjustable Union, Optional 7/8"-22 Swivel Nut or 316SS

Accuracy: ± 1 Scale Division

Calibration: External Reset Calibration Screw on back of case

Fill: Liquid or Mercury Actuated; Mercury over 500°F

Stem Length: Standard Lengths from 6" to 72"



PALMER DIAL THERMOMETERS ARE USED ON THE F-16

In 1972, the USAF awarded a contract to General Dynamics to produce a multi-use fighter jet that became known as the F-16 Fighting Falcon. As this new fighter was put into production, *Parker-Hannifin Control Systems Division* was enlisted to provide hydraulic system assemblies. In order to monitor the temperature of the hydraulic fluids in the system and to better assist with the maintenance of the aircraft, Parker turned to **Palmer Instruments** to help design and manufacture a tough and reliable thermometer for use in the hydraulic system assemblies for the aircraft.

Since the F-16 Fighting Falcon was approved for production in 1976, over 4,500 aircraft have been built. In addition to active duty U.S. Air Force, Air Force Reserve Command, and Air National Guard units, the aircraft is also used by the USAF aerial demonstration team, the U.S. Air Force Thunderbirds, and as an adversary/aggressor aircraft by the United States Navy. Although no longer being purchased by the U.S. Air Force, improved versions are still in production for service in the air forces of 25 other nations.

In 2005 Palmer Instruments began working with *Parker-Hannifin* and the US Air Force, the USAF to develop and produce an extended operating range thermometer, designed to serve in the higher temperatures experienced by the F-16 in the Middle East. **Palmer Instruments** is the preferred provider of this instrument, which is being used to retrofit the tough old war bird all over the globe.

Infrared

Digi-Stem

Hand Held Meters

Sensors

Temp-Plates

Thermometers

Thermowells

Recorders

Pressure Gauges

Calibration

Industrial Thermometers

Palmer Industrial Thermometers set industry standards for accuracy, quality, rugged operation and long term use.

A. Economy Industrial Thermometers

Model: 9FL, 9FLSB - 9" Plastic Case with Flex Angle Adjustment, Aluminum Scale
Range: -40° to 550°F or -40° to 550°F & C
Connection: 1-1/4"-18 UNEF Swivel Nut
Fill: Red Reading Mercury or Sky Blue Filled
Stem Length: 3.5", 6", 8", 9", 12"
Accuracy: ± 1 scale division

B. Economy Industrial Thermometers

Model: 9AL, 9ALSB - 9" Aluminum Case with Flex Angle Adjustment, Aluminum Scale
Range: -40° to 550°F or -40° to 550°F & C
Connection: 1-1/4"-18 UNEF Swivel Nut
Fill: Red Reading Mercury or Sky Blue Filled
Stem Length: 3.5", 6", 8", 9", 12"
Accuracy: ± 1 scale division

C. Classic Industrial Thermometers

Model: 200 Series - 12" Case; 300 Series - 9" Case
Range: 0° to 400°F or -18° to 205°C
Case/Scale: Extruded V Shaped Brass / Chrome Finish, with Flex Angle Adjustment, Painted Metal Scale
Connection: 1-1/4"-18 UNEF Brass Swivel Nut, SS optional
Fill: Red Reading Mercury or Red Spirit Filled
Stem Length: 3.5", 6", 8", 12"
Accuracy: ± 1/2 scale division, Red Spirit: ± 1 scale division

D. Prover Tank Thermometers (not pictured)

Model: 210 - 12" Brass Case/Chrome Finish, with Fixed Angle selections. Nickel Plated Scale to resist gasoline vapors
Range: 10° to 120°F
Connection: 1-1/4"-18 UNEF Brass Swivel Nut
Fill: Red Reading Mercury Filled
Stem Length: 3.5", 6", 8", 12"
Accuracy: ± 1/2 scale division

E. 2-1/2" - Wide Case Industrial Thermometers

Model: 2AA - 12", 3AA - 9" Wide Aluminum Case with Flex Angle Adjustment, Instrument Glass, Aluminum Scale
Range: -40° to 400°F or -40° to 400°F & C
Connection: 1-1/4"-18 UNEF Brass Swivel Nut, SS optional
Fill: Red Reading Mercury or Red Spirit Filled
Stem Length: 3.5", 6", 8", 12"
Accuracy: Within 1/2 scale division

F. 1-11/32" - Narrow Case Industrials

Model: 7AA - 6.5" Narrow Blue Painted Aluminum Case with Flex Angle Adjustment, Plastic Crystal, Aluminum Scale and Thermowell
Range: 0° to 240°F or 0° to 240°F & C
Connection: 1/2"-14 NPT Fixed
Fill: Sky Blue Filled
Stem Length: 2-1/4"
Accuracy: 1% of Full Scale

Palmer Industrial Thermometers

With looks to match their performance, our thermometers are designed and constructed for long-term industrial process service. For applications requiring fast response, choose a union model instead of a thermowell, specify one piece stem and bulb. Our Flex Angle Adjustment feature (see below) allows one thermometer to be "infinitely" adjusted to virtually any installation and viewing angle, greatly simplifying engineering and purchasing operations. Their versatility also aids in keeping both the inventory of "back-up" replacement thermometers and process down time at a minimum.



A

B

C

E

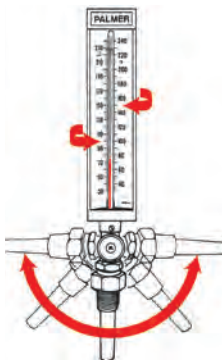

Flex Angle Adjustment

With Flex Angle Adjustment just two screws permit cases to be rotated 180° and stems to be positioned in 10° increments. Users can "infinitely" adjust Economy Line Industrial Thermometers to virtually any viewing angle required.

F

Specifications subject to change without notice

You know those thermometers with the red column?

We invented that...

The first Palmer Thermometer was designed by Richard Penny Palmer in the late 1800's. He aspired to make the very finest and most accurate thermometers possible. His son, Charles Palmer invented the red-reading-mercury thermometer in 1929, revolutionizing the industry. This radical improvement in the legibility in temperature reading was the most outstanding achievement in modern thermometers at the time.

Richard Palmer's guiding ideal has been faithfully and consistently adhered to, as today our Classic Industrials are made the same way they were back then.

Pictured at right: William Daley, an expert glass blower, with Palmer Thermometers in Cincinnati, Ohio for over 50 years.

Pictured far right: Palmer thermometer circa 1930.



G



H



G. PSP500 Solar Powered Digital Thermometer

Environmentally friendly mercury-free thermometers

Case: Hi-Impact ABS Case, with Flex Angle Adjustment and built-in Solar cell

Range: -50° to 300°F (-45° to 150°C) F/C Switchable

Display: 1/2" LCD digits, wide ambient formula

Accuracy: 1% of reading or 1°, whichever is greater

Resolution: 1/10° between -19.9° to 199.9°F (-28° to 93°C)

Recalibration: Through case potentiometer adjustment

Lux Rating: 10 Lux (one foot candle)

Update: 10 seconds

Ambient Temperature: -30° to 140°F (-35° to 60°C)

Ambient Temp Error: Zero

Humidity: 100%

Thermometer Sensor: Glass passivated Thermistor - NTC

Stem Material: Standard Cast Aluminum Stem and Seat

Fitting: 1-1/4"-18 UNEF Machined Brass Swivel Nut

Stem Assemblies: Direct Replacement for Industrial, Bimetallic, Air Duct

Stem Length: 2.5", 3.5", 4", 6", 9", 12",

H. PSP500 Solar Powered with 4-20 mA Transmitter

Same features as above, plus single unit with dual sensors allows for local reading and remote transmitting for convenient and reliable independent operation in a variety of applications

Transmitter Range: -58° to 302°F (-50° to 150°C)

Transmitter Output: 4-20 mA

Transmitter Ambient Temperature: -15° to 185°F (-25° to 85°C)

Transmitter Ambient Temp Error: 0.01% Span (°C)

Transmitter Supply: 8 to 35 VDC

Transmitter Max Load Resistance: 775W with 24 VDC Supply

Transmitter Accuracy: 0.1% of Span

Transmitter Thermometer Sensor: Thermistor based - NTC

Transmitter Sensor: Platinum 100WRTD



Palmer Thermowells

Proudly Made In The USA for over 70 years, Palmer's wide variety of thermowells protect both your temperature sensor and production process



Palmer has manufactured thermowells since the 1940's, and has gained an expertise unsurpassed in the industry. Our machined wells are built in our factory for complete control of the production process. Our attention to detail allows us to produce precision wells, allowing us to build to meet your needs and specifications. Palmer offers wells in a large variety of connections, bore sizes, stem lengths and materials, including exotic materials for all applications. We take great pride in producing the finest thermowells in our Asheville, NC plant. We are an ISO certified company, assuring our processes result in a top quality product.

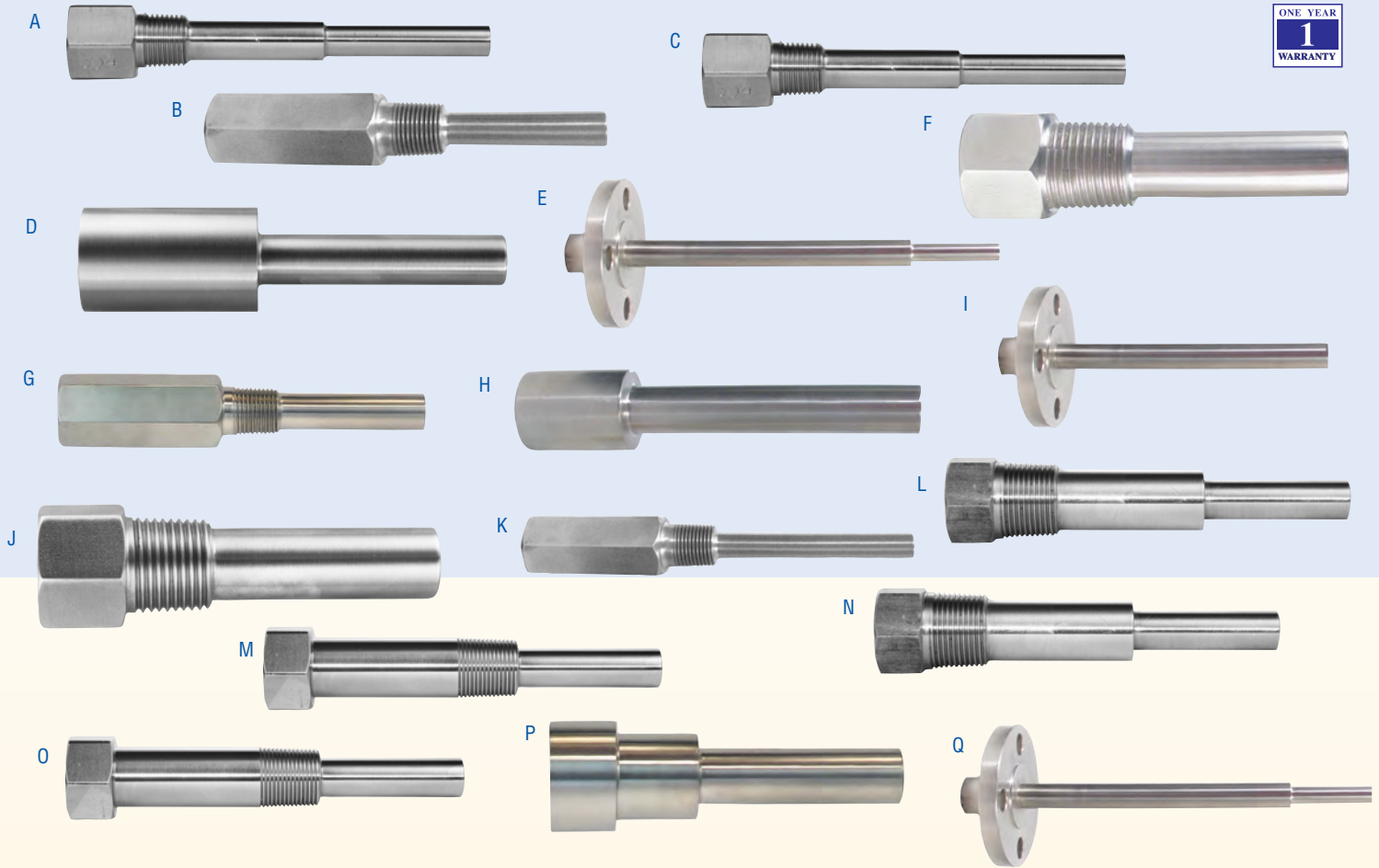

A. 1120 Series Threaded Regular

Bore: .260" Diameter Bore; 1/2"-14 NPS Internal Thread

B. 1121 Series Threaded Regular - Lagging

Bore: .260" Diameter Bore; 1/2"-14 NPS Internal Thread

C. 1124 Series Built-Up Threaded Regular

Bore: .260" Diameter Bore; 1/2"-14 NPS Internal Thread

C. 1125 Series Built-Up Threaded Regular - Lagging

Bore: .260" Diameter Bore; 1/2"-14 NPS Internal Thread (not pictured)

D. 1126 Series Weld-In

Bore: .260" Diameter Bore; 1/2"-14 NPS Internal Thread

E. 1127 Series Flanged

Bore: .260" Diameter Bore; 1/2"-14 NPS Internal Thread

F. 1130 Series Threaded Regular

Bore: .385" Diameter Bore; 1/2"-14 NPS Internal Thread

G. 1131 Series Threaded Regular - Lagging

Bore: .385" Diameter Bore; 1/2"-14 NPS Internal Thread

H. 1136 Series Weld-In

Bore: .385" Diameter Bore; 1/2"-14 NPS Internal Thread

I. 1137 Series Flanged

Bore: .385" Diameter Bore; 1/2"-14 NPS Internal Thread

J. 1138 Series Threaded Regular

Bore: .385" Diameter Bore; 1/4" -18 NPT Internal Thread

K. 1139 Series Threaded Regular - Lagging

Bore: .385" Diameter Bore; 1/4" -18 NPT Internal Thread

L. 1140 Series Threaded Regular with Tapered Bore

Bore: .437" Diameter Tapered Bore, .180" Taper per foot; 1-1/4"-18 NEF Internal Thread

M. 1141 Series Threaded Regular with Tapered Bore - Lagging

Bore: .437" Diameter Tapered Bore, .180" Taper per foot; 1-1/4"-18 NEF Internal Thread

N. 1144 Series Built-Up Threaded Regular with Tapered Bore

Bore: .437" Diameter Tapered Bore, .180" Taper per foot; 1-1/4"-18 NEF Internal Thread

O. 1145 Series Built-Up Threaded Regular with Tapered Bore - Lagging

Bore: .437" Diameter Tapered Bore, .180" Taper per foot; 1-1/4"-18 NEF Internal Thread

P. 1146 Series Weld-In with Tapered Bore

Bore: .437" Diameter Tapered Bore, .180" Taper per foot; 1-1/4"-18 NEF Internal Thread

Q. 1147 Series Flanged with Tapered Bore

Bore: .437" Diameter Tapered Bore, .180" Taper per foot; 1-1/4"-18 NEF Internal Thread

Specifications subject to change without notice

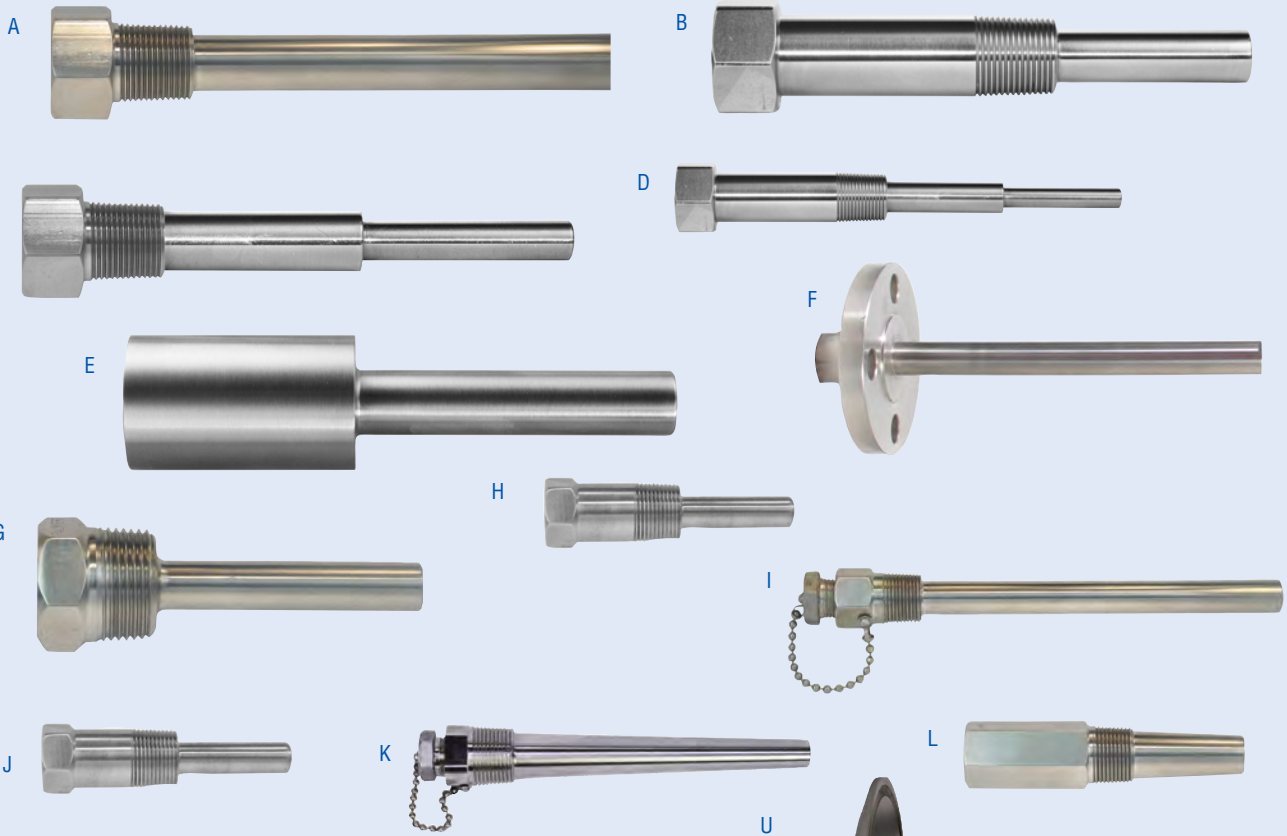

A. 1150 Series Threaded Regular

Bore: .501" Diameter Bore; 7/8"-22 NS Internal Thread

B. 1151 Series Threaded Regular - Lagging

Bore: .501" Diameter Bore; 7/8"-22 NS Internal Thread

C. 1154 Series Built-Up Threaded Regular

Bore: .501" Diameter Bore; 7/8"-22 NS Internal Thread

D. 1155 Series Built-Up Threaded Regular - Lagging

Bore: .501" Diameter Bore; 7/8"-22 NS Internal Thread

E. 1156 Series Weld-In

Bore: .501" Diameter Bore; 7/8"-22 NS Internal Thread

F. 1157 Series Flanged

Bore: .501" Diameter Bore; 7/8"-22 NS Internal Thread

G. 1160 Series Threaded Regular

Bore: .437" Diameter Bore; 7/8"-22 NS Internal Thread

H. 1161 Series Threaded Regular - Lagging

Bore: .437" Diameter Bore; 7/8"-22 NS Internal Thread

I. 1170 Series Threaded Regular - Test Wells

Bore: .437" Diameter Bore; 1/2"-14 NPS Internal Thread

J. 1171 Series Threaded Regular - Lagging - Test Wells

Bore: .437" Diameter Bore; 1/2"-14 NPS Internal Thread

K. 1172 Series Heavy Wall Threaded Regular - Test Wells

Bore: .437" Diameter Bore; 1/2"-14 NPS Internal Thread

L. 1173 Series Heavy Wall Threaded Regular - Lagging - Test Wells

Bore: .437" Diameter Bore; 1/2"-14 NPS Internal Thread

M. 1178 Series Protection Tubes (not pictured)

Bore: 1" Diameter Bore, Schedule 40 Wall Thickness

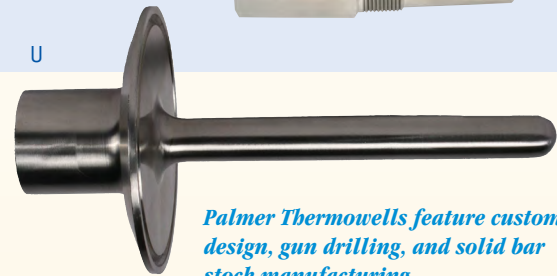

Palmer Thermowells feature custom design, gun drilling, and solid bar stock manufacturing.

N. 1179 Series Protection Tubes (not pictured)

Bore: 1" Diameter Bore, Schedule 80 Wall Thickness

O. 1180 Series Vanstone (not pictured)

Bore: .437" Diameter Bore; 1/2"-14 NPS Internal Thread

P. 1181 Series Vanstone (not pictured)

Bore: .260" Diameter Bore; 1/2"-14 NPS Internal Thread

Q. 1182 Series Vanstone (not pictured)

Bore: .385" Diameter Bore; 1/2"-14 NPS Internal Thread

R. 1183 Series Heavy Wall Weld-In (not pictured)

Bore: .437" Diameter Bore; 1/2"-14 NPS Internal Thread

S. 1186 Series Weld-In (not pictured)

Bore: .437" Diameter Bore; 1/2"-14 NPS Internal Thread

T. 1187 Series Flanged (not pictured)

Bore: .437" Diameter Bore; 1/2"-14 NPS Internal Thread

U. 1128 Series Sanitary Wells

Bore: .260" Diameter Bore; 1/2"-14 NPT Internal Thread

V. 26P Series Projectile Wells (not pictured)

Bore: .437" Diameter Tapered Bore; .180" Taper per foot; 1-1/4"-18 NEF2 Internal Thread

Choose Palmer - the RIGHT Thermowell for the job!

Pressure & Temperature Recorders

Designed for long service life in indoor or outdoor installations, even in harsh conditions.

Palmer Temperature & Pressure Recorders

Designed for indoor or outdoor use, our recorders provide long service life, even in harsh conditions. Palmer Recorders are available in 8" or 12" models, and come complete with either electric, spring wound, or PC-11 (battery operated) chart drive, and up to three (3) felt tip pens. Case mountings are wall, flush, pedestal, pipestand or portable. The combinations of case mounts and internals allow selections which meet your specific requirements without limiting performance or demanding a custom price.

Recorder Mounting

Wall Mount: Furnished with flexible armored capillary or pressure connection at the bottom of case unless otherwise specified.

Flush Mount: Furnished with armored capillary or pressure connection at the back of the case. Front door latch standard.

Pipestand Mount: Furnished with armored capillary or pressure connection at the bottom of case unless otherwise specified.

Portable: Supplied with flexible armor or pressure connection at the back of the case unless otherwise specified.

Pedestal Mount: Flexible armored capillary or pressure connection may be furnished at the back, top or bottom of case if specified.

A. Pressure Recorders

Case Mounting: Wall, Flush, Pipestand, Portable, or Pedestal

Chart Size: 8" & 12" **Pens:** 1, 2, or 3

Range: 0 to 30,000 PSI **Accuracy:** $\pm 1/2$ chart graduation

Chart Drive: PC-11 Battery, Electric or Spring Wound



B. Temperature Recorders

Case Mounting: Wall, Flush, Pipestand, Portable, or Pedestal

Chart Size: 8" & 12" **Pens:** 1, 2, or 3

Range: -40° to 1000°F **Accuracy:** ± 1 chart graduation

Chart Drive: PC-11 Battery, Electric or Spring Wound

C. Pressure & Temperature Recorders

Case Mounting: Wall, Flush, Pipestand, Portable, or Pedestal

Chart Size: 8" & 12" **Pens:** 1, 2, or 3

Range: 0 to 30,000 PSI / -40° to 1000°F

Accuracy: Pressure: $\pm 1/2$ chart graduation; Temperature: ± 1 chart graduation

Chart Drive: PC-11 Battery, Electric or Spring Wound



Wall Mount



Pedestal Mount

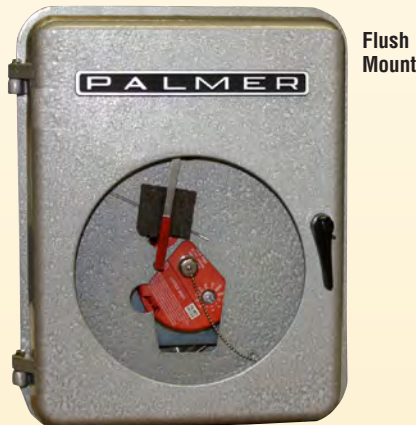

Flush Mount



Portable



Pipestand Mount

D. PC-11 Quartz Multi-Speed Chart Drive

Designed for outdoor use, Palmer's hermetically sealed PC-11 operates reliably even in wet and dirty environments. Freezer tested to -40°F , it will withstand extreme temperatures. The highly adaptable design will fit any chart recorder, and makes exchange in the field a snap. The eleven speed dial on the front of the case allows field selectable recording intervals from 60 minutes to 32 days. The dial also turns the unit off to conserve battery power. A pulsating LED indicator behind the dial shows that the battery is charged and that the unit is operating. Our PC-11 is rated intrinsically safe, which makes it ideal for use by gas utility companies and in other situations where hazardous or combustible materials are present.

- 11 Speeds: switch selectable, choose from 60 min., 96 min., 12 hr., 1 day, 2 day, 7 day, 8 day, 14 day, 16 day, 31 day or 32 day recording intervals
- Universal Mounting Bracket: fits all chart recorders for easy replacement
- .25" Drive Shaft: With flat, accepts different drive hubs
- Maintenance-Free: Closed construction case protects all moving parts



D

E. Pressure Elements

E1. High Pressure Material: 316 SS helical coil with SS Fittings and tubing for ranges 30 to 30,000 PSI.

E2. Low Pressure Material: Beryllium copper diaphragm silver brazed to copper tubing and brass fittings, for ranges below 30 PSI

Accuracy: $\pm 1/2$ chart graduation

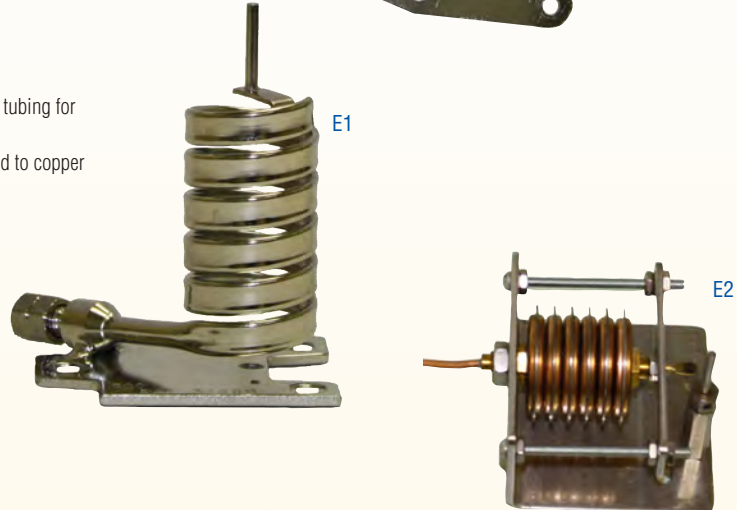

E1

E2

F. Temperature Elements

Case Mounting: All mercury filled systems are pressurized for overrange capabilities and rapid response. The system is completely welded to prevent deterioration, reinforced with added flexible armor.

Accuracy: ± 1 chart graduation

Length: Capillary Length up to 25 ft.

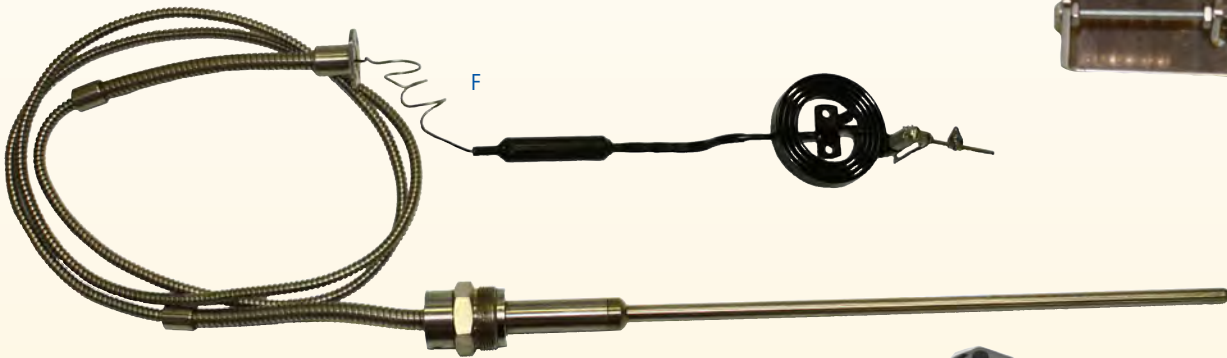

F

G. FD5 Data Logger

The **NEW!** FD5 Digital Datalogger is the new generation of data acquisition systems. All the necessary software is embedded in the unit, allowing you to program and read data from any computer! FD5 acquires up to 400 data samples per second from one channel. Acquisition speed is the same no matter the number of active channels. Select between 5, 10 or 15 channels, depending on model, and additional channels can be added modularly. The internal memory of 1,000,000 data samples can be expanded using an SD card or USB drive, offering several months of storage. The 5 TTL inputs/outputs can be used to trigger acquisitions or events. Two analog outputs, (0-10V), are also included.

- Accept 5 to 15 synchronous differential and universal analog inputs
- Multiple communication modes available including: Ethernet, USB, RS232 and RS485
- Data processing, statistics, conditioning, Boolean calculations



Specifications subject to change without notice



G

Pressure Gauges

Great gauges stocked for you so you can ship from our warehouse as needed!



Palmer Fearless Gauges rugged construction and design is enhanced by Palmer's vibration and pulsation resistant Dampened Movement. The results are a Pressure Gauge suitable for demanding applications in all industries.

A. Fearless All Stainless Steel Gauges

Model: 25SF, 40SF
Dial Size: 2.5", 4"
Tube/Socket: AISI 316 SS
Connection: 1/4" NPT, 1/2" NPT
Range: 0-15,000 PSI, -30" Hg/160#, Bar, kg/cm2, kPa
Rating: IP54



A

B. Gas Test Gauges

Model: 40KB
Dial Size: 4"
Tube: Phosphor Bronze Diaphragm Internals
Socket/Connection: Lower Connected Brass Valve Body with Schrader Valve, and 3/4" NPT Process Connection
Range: 6 PSI / 12" Hg or 15 PSI / 30" Hg
Rating: IP41

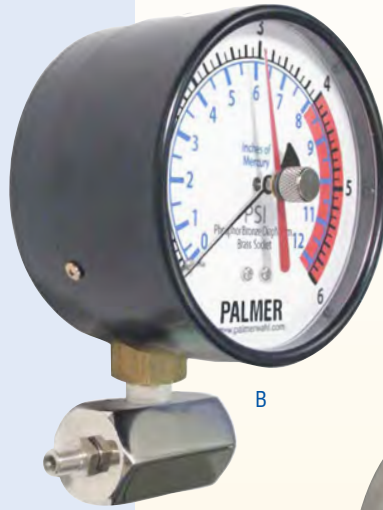

B

C. All Stainless Steel Gauges

Model: 25CS, 25SS, 40SS, 60SS
Dial Size: 2.5", 4", 6"
Tube/Socket: AISI 316 Stainless Steel
Connection: 25CS/25SS: 1/4"; 40SS/60SS: 1/2" NPT
Range: 0-20,000 PSI, -30" Hg/160#, Bar, kg/cm2, kPa
Rating: Filled Gauge: IP64; Dry Gauge: IP54

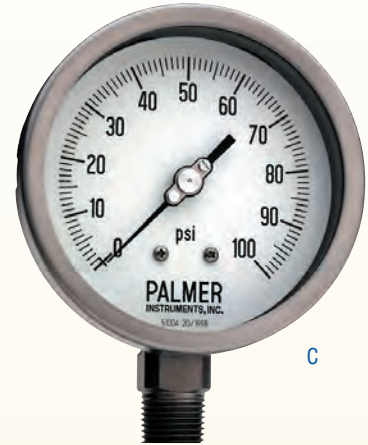

C

D. Current Loop Transmitter Gauge

Model: 40ES with 4 - 20 mA Output
Dial Size: 4"
Tube/Socket: AISI 316L SS
Connection: 1/2" NPT, 1/4" optional
Range: 0-20,000 PSI, 0-1600bar
Rating: Filled Gauge - IP67 Dry Gauge - IP55



D

E. Low Pressure Gauge

Model: 25PP, 40PP, 60PP, 25SC, 40SC, 60SC
Dial Size: 2.5", 4", 6"
Tube/Socket: PP Models: Brass, SC Models: AISI 316 SS
Connection: PP Models: 1/4" NPT, SC Models: 1/2" NPT
Range: 0-10 PSI, -30/200" H₂O, Vac
Rating: IP41

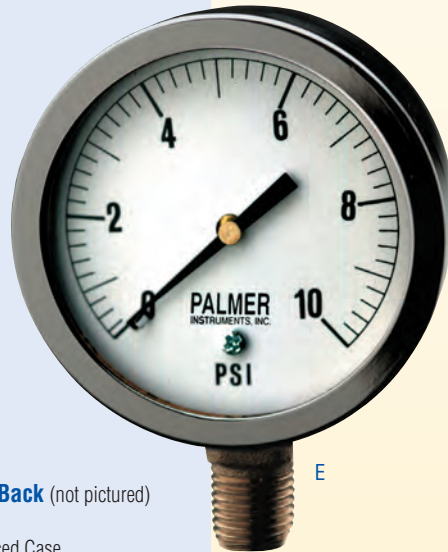

E

F. Brass Case Gauge

Model: 25BB
Dial Size: 2.5"
Tube/Socket: Phosphor Bronze
Connection: 1/4" NPT
Range: 0-10,000 PSI, -30" Hg
Rating: IP54



F

G. Solid Front Gauges with Blow Out Back (not pictured)

Model: 40FS, 4" Stainless Steel Case
Model: 45TS, 4.5" Phenolic, Fiberglass Reinforced Case
Tube/Socket: AISI 316 SS Tube & Socket, 45TS optional K Monel
Connection: 1/2" NPT, optional BSP
Range: 0-20,000 PSI, -30" Hg/300#, Bar, kg/cm2, kPa
 Single or Dual Ranges available
Rating: 40FS - Filled Gauge: IP67; Dry Gauge: IP55



Dry Gauges



Wet Gauges

H. Stainless Steel Case Gauges

Model: 15CB, 20CB, 25CB, 40CB
Dial Size: 1.5", 2", 2.5", 4"
Tube: Brass or Phosphor Bronze
Socket: Brass
Connection: 1/8" NPT (15CB only), 1/4" NPT
Range: 0-4,000 PSI, -30" Hg/300#
Rating: IP54

I. Sanitary Gauges

Model: 40SS
Dial Size: 4"
Tube/Socket: AISI 316 SS
Connection: 1-1/2" Tri-Clamp, 2" Tri-Clamp
Range: 0-1,000 PSI, -30" Hg/30#
Rating: IP55

J. Electrical Contact Gauges

Model: 40HB, 40HS
Dial Size: 4"
Tube: 40HB: Copper Alloy, AISI 316L SS over 870 PSI 40HS: AISI 316L SS
Socket: 40HB: Copper Alloy, 40HS: AISI 316L SS
Connection: 1/2" NPT
Range: 15-20,000 PSI, Bar, kPa, MPa
Rating: Filled Gauge: IP65; Dry Gauge: IP55
Electric Contacts: Single or Double

K. Steel Case Gauges

Model: 15PB, 20PB, 25PB, 40PB
Dial Size: 1.5", 2", 2.5", 4"
Tube/Socket: Brass or Phosphor Bronze
Connection: 1/8" NPT on 1.5", 1/4" NPT on 2", 2.5", 4"
Range: 0-600 PSI, -30" Hg
Rating: IP40

L. Differential Gauges

Model: 40MS
Dial Size: 4"
Tube/Socket: AISI 316 SS
Connection: 1/2" NPT
Range: 0-800 PSI
Rating: IP45

M. Contractor Gauges

Model: 45SB
Dial Size: 4.5"
Tube/Socket: Brass
Connection: 1/4" NPT
Range: 0-500 PSI, -30" Hg
Rating: IP40

N. Solar Digital Gauges

Model: PSP100
Display: LCD with (4) 5/8" high digits
Blow-out Back: Solid Front, IP65
Connection: 1/4" NPT or 1/2" NPT
Range: Vacuum to 1,000 PSI
Rating: IP65

O. Solar Transmitter Gauges

Model: PSP150 with 4-20 MA output (requires loop power 9-35 VDC) (not pictured)
Display: LCD with (4) 5/8" high digits
Blow-out Back: Solid Front, IP65
Connection: 1/4" NPT or 1/2" NPT
Range: Vacuum to 1,000 PSI
Rating: IP65

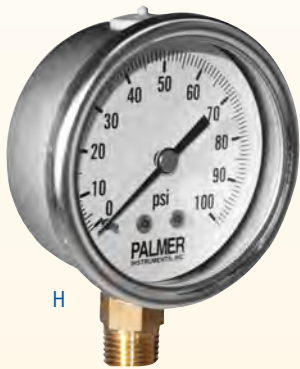

H

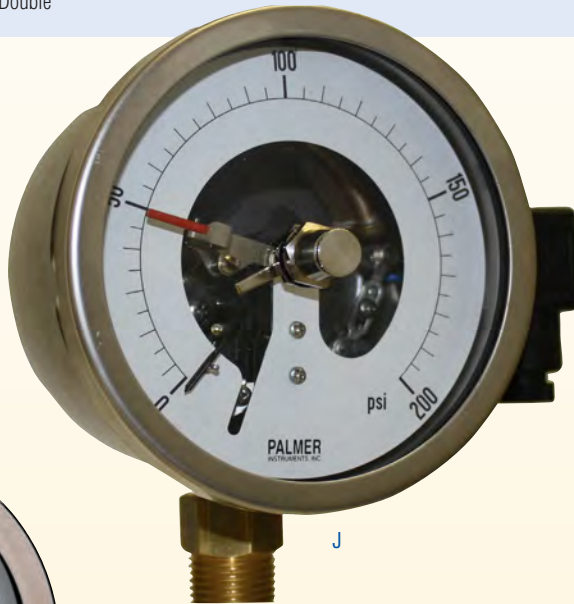

L



N



I

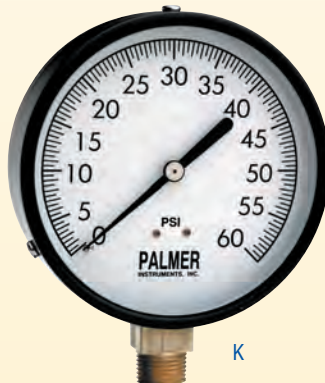

K

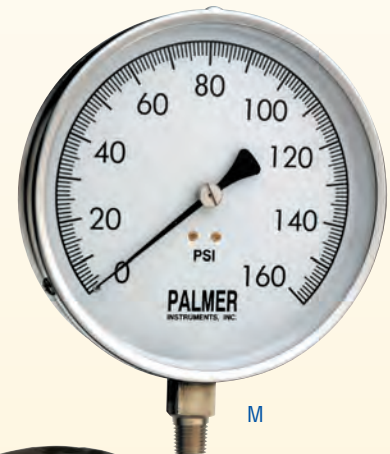

M



N

Specifications subject to change without notice

Pressure Gauges, Pressure Transducers, and MPT Pressure Tester

A. Aero Type Low Pressure Differential Gauges

Series: J-2000 Series

Case: 4" (100mm); Corrosion resistant, die cast aluminum case and bezel; Standard Flush Mount, optional Surface Mount

Pointers: Patented Safe-Slide Pointers slide around the lens, allowing the user to set Safe, Warning, and Danger Points; all easily visible at a distance

Range Availability: inH₂O, PSI, cmH₂O, mmH₂O, Pa, kPa

Process Connection: High and Low Pressure: 1/8" drill tube thread on back and side

Accuracy: ± 2% of Full Scale

Rating: IP54



A

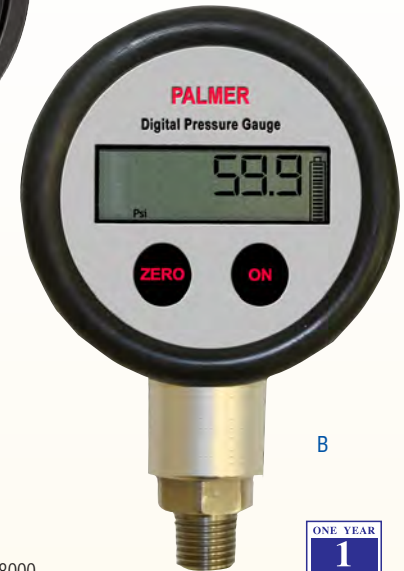

B



B. Digital Pressure Gauges

Series: EDG with User Selectable Resolution, Engineering Units, Modes, and single point calibration

Case: Protective Rubber Boot provides impact dampening

Range Availability: Units for clean gas as low as vacuum and as high as 300 PSI. Corrosive gas units from 0 to 200 PSI. Pressure reset/zero button

Process Connection: 1/4" NPT, bottom connected

Internals: Upgraded internals for corrosive models to 316 SS, with 304 SS connection

Accuracy: ± 1% Full Scale. ± 1 digit

Rating: IP54 with Boot; IP40 without Boot

Battery: Standard 9V battery; conservation mode with auto off timer, user adjustable from 5 to 180 seconds in 5 second intervals; good for 8000 cycles (180 sec. per cycle with 300 sec. intervals) or approximately 1500 hours - reducing cycle time will extend battery life

C. Diffuse Silicone Sensor Level Transmitters

Series: PPT400 - **DISCONTINUED**

Measurement Range: 0 to 200 mmH₂O

Output: 4-20 mA, 0-5V

Accuracy: 0.25% Full Scale (includes linearity, repeatability and hysteresis)

Overpressure Limit: 2.5 times Full Scale

Long Term Stability: ± 0.2% of Full Scale per year

Response Time: 10 ms

Power Supply: 24 VDC

Electrical Connection: Non-polar, 2 wire current output

Rating: IP67



C

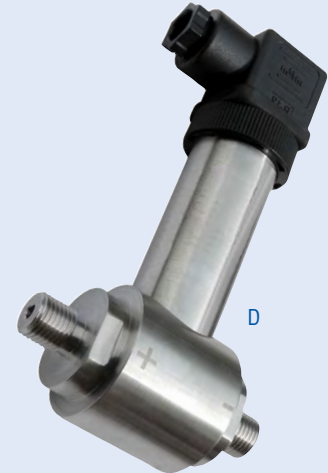

D

D. Differential Pressure Transducers/Transmitters

Series: PPT500 - **DISCONTINUED**

Measurement Range: 1 to 290 PSI (0.01 to 2 MPa) Gas,

0 to 1450 PSI (0.03 to 10 MPa) Liquid

Output: 4-20 mA, 0-5 V

Accuracy: 0.25% Full Scale (includes linearity, repeatability and hysteresis)

Overpressure Limit: 2.5 times Full Scale

Long Term Stability: ± 0.15% of Full Scale per year

Response Time: 10 ms

Power Supply: 24 VDC

Electrical Connection: DIN

Rating: IP65

E. Economy Ceramic Piezoresistive Pressure Transducers

Series: PPT1200R - **DISCONTINUED**

Measurement Range: 29 to 8700 PSI (0.2 to 60 MPa)

Output: 4-20 mA

Accuracy: 0.5% Full Scale

Overpressure Limit: 1.5 times Full Scale

Response Time: 10 ms

Power Supply: 24 VDC

Electrical Connection: DIN

Rating: IP65



E



Specifications subject to change without notice



Palmer's NEW Multi-Thread Pressure Tester

The patented MPT Tester eliminates special testing apparatus and makeshift manifolds for rough and finish inspections - making them more economical, less labor intensive and 100% easier.

Just screw it on and the MPT will fit multiple thread sizes!

F. MPT PRO Tester

Model: MPTP
End Ports: Three 1/4" NPT Ports
Internal Threads: Six NPT Threads
 1/2", 3/4", 1", 1-1/4", 1-1/2", 2" NPT
Pressure Limit: 5,000 PSI
Material: Aircraft Aluminum



G. MPT CRAFTSMAN Tester

Model: MPTC
End Ports: One 1/4", Two 3/4" NPT Ports
Internal Threads: Six NPT Threads
 1/2", 3/4", 1", 1-1/4", 1-1/2", 2" NPT
Pressure Limit: 5,000 PSI
Material: Aircraft Aluminum



H. MPT ACE Tester

Model: MPTA
End Ports: Three 1/4" NPT Ports
Internal Threads: Four NPT Threads
 3/8", 1/2", 3/4", 1" NPT
Pressure Limit: 1,000 PSI
Material: Aircraft Aluminum



I. MPT MINI Tester

Model: MPTM
End Ports: Three 1/4" NPT Ports
Internal Threads: Three NPT Threads
 1/8", 1/2", 3/4" NPT
Pressure Limit: 1,000 PSI
Material: Aircraft Aluminum



J. MPT INDUSTRIAL KIT

Model: MPTKI
INCLUDES: MPTP PRO Tester
 MPTC CRAFTSMAN Tester
 MPTA ACE Tester
 60" H₂O, 35oz Gauge
 34 kPa, 5 lb Gauge
 Mini Ball Valve
 Hand Pump with Check Valve
 Schrader Valve
 1/4" Male Quick Connect Fitting
 Hose Bib Adaptor for Hydrostatic Testing
 1/4" x 1/8" Hose Connection

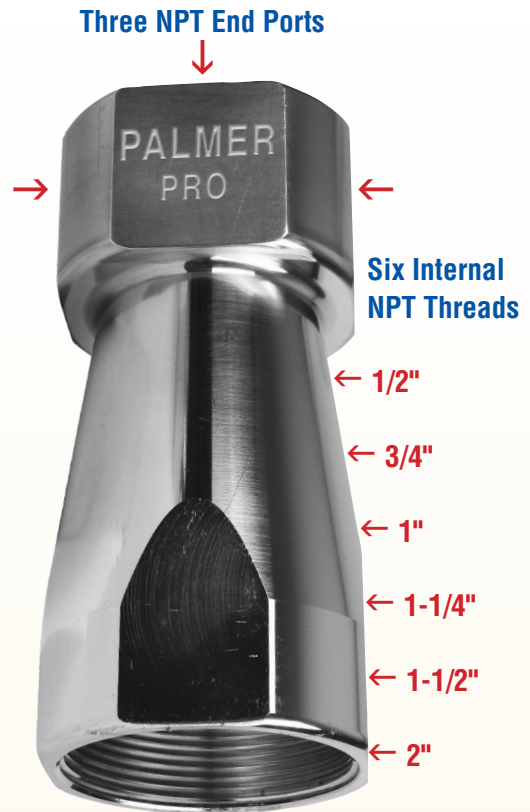

Industries that use Pressure Testers

Gas Lines	Pipe Fitting
HVAC/Vents	Plumbing
Hydraulic Lines	Sprinkler Systems
Irrigation Systems	Utility Lines
Medical Gas Lines	Water/Waste Lines
Natural Gas	and more!

www.palmermpt.com

Also available: Contractor, Residential, Fire Sprinkler and Starter Kits

Pressure Pumps and Precision Test Gauges



A

NEW! Hydraulic Calibration Pressure Pump

The NEW! Palmer PV10K Hydraulic Calibration Pressure Pump is a high quality hand pump designed to quickly and easily generate hydraulic pressures. Its construction makes it compatible with most fluid media, and an optional seal kit can be supplied for aggressive applications. The built-in vernier provides excellent control and is easy to adjust even at high pressures. The dual stage pump includes a selector valve which increases the priming speed and greatly reduces the effort required to generate high pressures. Optional pressure relief valve can be supplied to provide protection to connected instruments.

A. Hydraulic Calibration Pressure Pump

Model: PV10K

Range: 0 to 10,000 PSI / 0 to 700 bar

Connection: 1/4" NPT or BSP Female Connections

Construction Materials: Series 300 stainless steel, brass, nickel plated brass, Pyrex™, Nitrile, polyurethane and PTFE. Compatible with most hydraulic fluids, oils and water

Dimensions: 9" x 6.25" x 2.75" (228 mm x 159 mm x 70 mm)

Weight: Approximately 3.2 lbs (1.4 kg)



NEW! Combination Pneumatic Pressure and Vacuum Pump

The NEW! Palmer PV600 Combination Pneumatic Pressure and Vacuum Pump is a lightweight yet high quality combination pressure and vacuum hand pump, designed to provide maximum pneumatic pressures efficiently and effortlessly.

B. Combination Pneumatic Pressure and Vacuum Pump

Model: PV600

Range: 28 inHg Vacuum to 600 PSI

Connection: 1/4" Female Gauge and Process Connections

Construction Materials: Bright nickel plated brass, anodized aluminum, phosphor bronze (springs), Nitrile, nylon

Dimensions: 8.5" x 4" x 2.5" (216 mm x 101 mm x 63 mm)

Weight: 1 lb (0.45 kg)



B

NEW! Precision Test Gauge

Designed for field and laboratory applications for precision pressure measurement and field gauge calibration. The PTG100 Series is an ideal substitution for precision pointer pressure gauges.

- Pressure ranges to 2500 bar
- Up to nine selectable pressure units
- Fully temperature-compensated accuracy from 32° to 122°F (0° to 50°C)
- Low power consumption, continuous working time up to 10,000 hours in non-sleep mode
- 2-Point filed calibration capability
- Auto peak recording

C. Model PTG100

Accuracy: 0.025% of full scale; 0.05% of full scale; 0.1% of full scale; 0.5% of full scale

Display: 6 full digit LCD with LED Backlight

Pressure Units: User selectable Pa, kPa, MPa, PSI, bar, mbar, inH₂O, mmH₂O, inHg, mmHg depending on range and resolution capabilities of the gauge

Compensated Temperature: 32° to 122°F (0° to 50°C). *0.025% Full Scale accuracy guaranteed only over the ambient temperature range of 68° to 77°F (20° to 25°C)

Storage Temperature: -4° to 158°F (-20° to 70°C)

Humidity: < 95%

Media Compatible: 0 to 0.16 Bar: Non-corrosive Gas compatible, 0.35 to 2500 Bar: Liquid, Gas or Steam Compatible with 316SS

Pressure Port: 1/4" NPT, optional 1/4" to 1/2" SS Adaptor

Battery: 3 AA Alkaline Batteries, User Replaceable

Battery Life: 1 year under normal working conditions. Battery life will vary depending on the frequency of readings

Case Material: Aluminum alloy

Wetted Parts: 316L SS, Differential Gauge has brass internals for clean gas applications only

Dimensions: 3.9" Diameter x 1.4"; Depth x 6.1"; Height (100 mm x 37 mm x 157 mm)

Weight: 1 lb (0.45 kg)

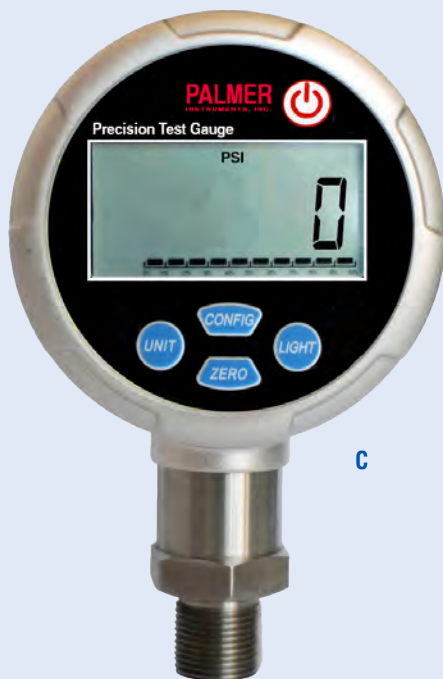

C

Specifications subject to change without notice

NEW! Digital Pressure Gauge

Designed for field and laboratory applications for precision pressure measurement and field gauge calibration. The PTG200 Gauge features non-volatile memory which will retain recorded data, even if battery power is lost.

- Pressure ranges to 2500 bar
- Full Scale Accuracy: 0.1%, 0.2%
- Fully temperature-compensated accuracy from 32° to 122°F (0° to 50°C)
- Up to nine selectable pressure units display
- Low power consumption, continuous working time up to three years under non-sleep mode
- 2-Point filed calibration capability

D. Model PTG200

Accuracy: 0.1% of full scale; 0.2% of full scale

Display: 5 full digit LCD with LED Backlight

Pressure Units: User selectable Pa, kPa, MPa, PSI, bar, mbar, inH₂O, mmH₂O, inHg, mmHg depending on range and resolution capabilities of the gauge

Compensated Temperature: 32° to 122°F (0° to 50°C)

Storage Temperature: -4° to 158°F (-20° to 70°C)

Humidity: < 95%

Media Compatible: 0 to 0.16 Bar: Non-corrosive Gas compatible,
0.35 to 2500 Bar: Liquid, Gas or Steam Compatible with 316SS

Pressure Port: 1/4" NPT, optional 1/4" to 1/2" SS Adaptor

Battery: 3 AA Alkaline Batteries, User Replaceable

Battery Life: 1 year under normal working conditions. Battery life will vary depending on the frequency of readings

Case Material: Aluminum alloy

Wetted Parts: 316L SS, Differential Gauge has brass internals for clean gas applications only

Dimensions: 4.5" Width x 3.5" Depth x 6.1"; Height (115 mm x 90 mm x 157 mm)

Weight: 1 lb (0.45 kg)



NEW! High Precision Digital Reference Pressure Recorder

Battery powered pressure recorder with an LCD display. Available on-screen data includes: statistics, recording status, display options, and calibration information. Statistics can be cleared at any time during logging. With 262,143 readings, this gauge has one of the largest memory capacities of similar data recorders on the market. The non-volatile memory will retain recorded data, even if battery power is lost. With supplied software, data is downloaded and ready for review and export to Excel. Serial connection is also available.

- Pressure Ranges to 2,500 bar
- User selectable measurement units
- 2-Point filed calibration capability
- Real-time operation, high speed download
- Advanced temperature compensation

E. Model PTG300 - THIS PRODUCT IS CURRENTLY UNAVAILABLE

Accuracy: 0.05% of full scale; 0.1% of full scale; 0.5% of full scale

Display: 6 full digit LCD with LED Backlight

Pressure Units: User Selectable Pa, kPa, MPa, PSI, bar, mbar, inH₂O, mmH₂O, inHg, mmHg depending on range and resolution capabilities of the gauge

Response Time: 0.1 mS

Start/Stop Time: Software programmable start time and date, up to six months in advance

Compensated Temperature: 32° to 122°F (0° to 50°C)

Storage Temperature/ Humidity: -4° to 158°F (-20° to 70°C), < 95%

Media Compatible: 0 to 0.16 Bar: Non-corrosive Gas compatible, 0.35 to 2500 Bar: Liquid, Gas or Steam Compatible with 316SS

Pressure Port: 1/4" NPT, optional 1/4" to 1/2" SS Adaptor

Over Pressure Warning: 120%

Battery: 3 AA Alkaline Batteries, User Replaceable

Battery Life: 1 year under normal working conditions. Battery life will vary depending on the frequency of readings

Reading Rate: Adjustable from 1 reading every 2 seconds to 1 every 24 hours

Case Material: Aluminum alloy

Wetted Parts: 316L SS, Differential Gauge has brass internals for clean gas applications only

Dimensions/ Weight: 3.9" Diameter x 1.4" Depth x 6.1" Height (100 mm x 37 mm x 157 mm), 1 lb (0.45 kg)

Communication: RS232 (DB9/F, environmentally sealed)

Baud Rate: 115200

Software: included, Windows compatible



Test & Calibration Instruments

Simple and robust to meet the needs of today's higher accuracy transmitters and sensors

A. TC Pocket Thermocouple Calibrator

Model: TC621

Sensing Element: Thermocouple

Probe Connection: Mini-Compensated Connector

Probes: Thermocouple Types: K, T, J, E, R, S, B, U, L, C, N, Platinum, MO, NiMo/NiCo

Display Resolution: 3 user selectable resolutions (up to 3 decimal places: High, Middle or Low resolution.

Statistics: Calculate Max, Avg, Min statistics; Simulate steps

Meter Accuracy: 0.02%

Language: 5 user selected languages; English, French, Spanish, German and Italian

Power Supply: 4 AA batteries, optional rechargeable battery pack with charger available

Rating: IP54

B. TC Pocket RTD Calibrator

Model: TC622

Sensing Element: RTD

Probe Connection: 4 pin round connector or 4 banana plugs

Probes: RTD: Types: Pt 50, Pt 100, Pt 200, Pt 500, Pt 1000, Ni 100, Ni 120, Ni 1000, and Cu 50

Display Resolution: 3 user selectable resolutions (up to 3 decimal places: High, Middle or Low resolution.

Statistics: Calculate Max, Avg, Min statistics; Simulate steps

Meter Accuracy: 0.02%

Language: 5 user selected languages; English, French, Spanish, German and Italian

Power Supply: 4 AA batteries, optional rechargeable battery pack with charger available

Rating: IP54

Process Signal Calibrator

The Wahl P32 Process Signal Pocket Calibrator has been designed with increased performance in order to meet the demands of today's higher accuracy transmitters and process sensors. Accuracy of 0.015% of reading allows the P32 to be used as a standard for on site operations. The P32 features adjustable display resolution to simplify measurements with maximum resolutions of 1 μ A and 1mV.

C. Process Signal Pocket Calibrator

Model: P32 DC Voltage, DC Current, Measurement and Emission

Probe Connection: Quick Connect Terminals with 4 mm banana plugs

Measurement: up to 50V

Simulation: up to 15V

Measurement and Emission: up to 25mA

Measurement Functions: Compatible with HART Transmitters

Scaling: 2 Scaling modes available

Display Resolution: User Adjustable

Statistics: Calculate Max, Avg, Min statistics; Simulate steps

Meter Accuracy: 0.015%

Language: 5 user selected languages; English, French, Spanish, German and Italian

Power Supply: 4 AA batteries, optional rechargeable battery pack with charger available

Rating: IP54

Handheld Calibrators for Maximum Portability

User friendly and robust, the Wahl TC Series Pocket Calibrators are designed to simplify temperature transmitters and probes maintenance and commissioning. They feature 0.02% Accuracy and measure and simulate Thermocouples or RTD's. Resolution is programmable for better reading by user with up to 1m Ω or 1uV.

Well adapted for different process job procedures due to their wide choice of ranges and specific functions such as scaling and ramping.

- High accuracy of 0.02% of reading
- Measurement and simulation of 14 thermocouples and 12 RTD types



A



B



C

Specifications subject to change without notice

Portable Multifunction Calibrators

The Wahl C Series Portable Multifunction Calibrators integrate all the necessary functions for calibration and maintenance of processes, making them the ideal instruments for maintenance, quality control, and calibration. The ergonomic design and embedded software makes them easy to use high performance calibrators. All models are in the same housing as shown right, and are powered by a rechargeable NIMh battery.



D. C50 Portable Multifunction Calibrator

Top Accuracy: 200 ppm
Temperature Accuracy: 0.013% RDG for TcK; 0.012% RDG
DC Current & Loop Supply: Up to 50 mA; 0.0175% RDG
DC Voltage: up to 50 V In / 20 V Out; 0.013% RDG
Frequency: Up to 20 KHz In / Up to 10 KHz Out; 0.005% RDG
Resistance: Up to 4000 Ω ; 0.012% RDG Ω
Pressure: Limited HART Protocol compatible functions

E. C75 Portable Multifunction Calibrator with Memory and Pressure (not pictured)

Top Accuracy: NA
Temperature Accuracy: NA
DC Current & Loop Supply: NA
DC Voltage: Up to 50 V; 0.013 RDG
Frequency: Up to 20 KHz In; Up to 10 KHz Out; 0.005% RDG
Resistance: Up to 4000 Ω ; 0.012% RDG
Pressure: Relative pressure: up to 30 bar; Absolute pressure up to 1000 bar; 0.05% RDG, Limited HART Protocol compatible functions

F. C100 Portable Multifunction Calibrator with Memory, Pressure and Laboratory Accuracy (not pictured)

Top Accuracy: 130 ppm
Temperature Accuracy: 0.01% RDG for TcK; 0.01% RDG
DC Current & Loop Supply: Up to 50 V; 0.0175% RDG
DC Voltage: Up to 50 V; 0.010% RDG
Frequency: Up to 20 KHz In / Up to 10 KHz Out; 0.005% RDG
Resistance: Up to 4000 Ω ; 0.010% RDG
Pressure: Relative pressure: up to 30 bar; Absolute pressure up to 1000 bar; 0.05% RDG, Limited HART Protocol compatible functions

G. C150 Portable Multifunction Calibrator with Memory, Pressure, High Accuracy and Dual Input (not pictured)

Top Accuracy: 50 ppm
Temperature Accuracy: 0.005% RDG for TcK; 0.006% RDG
DC Current & Loop Supply: Up to 100 mA; 0.007% RDG
DC Voltage: Up to 50 V; 0.005% RDG
Frequency: Up to 100 KHz In; 0.01% RDG
Resistance: Up to 3600 K Ω ; 0.006% RDG
Pressure: Relative pressure: up to 30 bar; Absolute pressure up to 1000 bar; 0.05% RDG
Compliance: 21 CFR Part 11 / NADCAP Heat Treatment Standards
HART Protocol Compatibility: HART: digital calibration and data transfer. Calibration of thermistors.

H. T150 High Precision All-in-One Temperature Field Calibrator for T/C, RTD, and Thermistors (not pictured)

Channels: 2 channels: IN / IN or IN / OUT configurable
Top Accuracy: 50 ppm
Thermocouple Accuracy: 0.005% RDG
RTD Accuracy: 0.006% RDG
Thermistor Accuracy: 0.006% RDG
Compliance: 21 CFR Part 11 / NADCAP Heat Treatment Standards
Key Features: 50 K Ω range and Steinhart-HART equation for Thermistors

Features of the C Series Calibrators

- Simultaneous Measurement and Generation
- Rugged IP54 Construction for On-Site Use
- Quick Connect Terminals
- Measure and Generate Voltage, Current and Resistance Signals
- Temperature by Resistive Probes and Thermocouples
- Frequency for Frequency Signals and for Dry Contacts
- Compliant with 21 CFR Part 11

All models (except the C50) feature advanced data exploitation: scaling, relative measurement, simulation of ramps and steps, synthesizer, square root, statistical function, calibration of transmitters and utilize DATACAL calibration software. They also feature transmitter function, switch test, and memory.

Why you need a Wahl Calibrator for your business

- Increase customer satisfaction with consistent products.
- Comply with quality standards.
- Improve product quality.
- Ensure traceability throughout your entire manufacturing process.
- Integrate all the necessary functions for adjustment and maintenance of your process.
- Our products are easy to use and Palmer Wahl is there to help, every step of the way.

Infrared

Digi-Stem

Hand Held Meters

Sensors

Temp-Plates

Thermometers

Thermowells

Recorders

Pressure Gauges

Calibration

Black Body Calibration Sources

Calibrate infrared thermometers and thermal imagers quickly and accurately



D

Easy Calibration

NEW! Wahl Black Body Temperature Calibration Sources are controlled and predictable, featuring targets with dull, black surfaces for an emissivity as close to 1 as possible.

Built-in or stand-alone digital temperature controllers with each unit provide accurate, stable temperatures while displaying the temperature readings of the calibration source. The heated plate

or cavity provides a target of known temperature and emissivity, and virtually any infrared thermometer with a spot size diameter less than the cavity size can be calibrated. Models with communication ports are capable of PC programming to control temperature set points for automatic test applications.

With stable, repeatable results Wahl Black Body Calibration Sources allow the user to ensure uniformity.



E

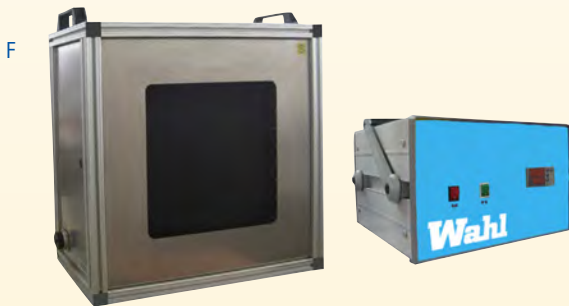

F



G



A

Surface Hot Plate Type

A. Model: CBB13EC

Working Temperature: Ambient 5° to 40°C Adjustable

Environment Temperature: 0° to 40°C

Temperature Stability: ± 0.1 to 0.2°C per hour

Aperture Type/Diameter: Ambient Square, 2.75 x 2.75 inches (70 x 70 mm)

Temperature Resolution: 0.1°C

Measuring Accuracy: ± 0.2°C @ 40°C

B. Model: CBB14AC (not pictured)

Working Temperature: 300° to 600°C

Environment Temperature: 0° to 40°C

Temperature Stability: ± 0.3 - 0.5°C per hour

Aperture Type/Diameter: Uncooled Round, 3.15 inches (80 mm)

Temperature Resolution: 0.1°C

Measuring Accuracy: ± 0.3% of full scale + 1.0°C

C. Model: CBB14KC (not pictured)

Working Temperature: -20° to 60°C

Environment Temperature: 0° to 40°C

Temperature Stability: ± 0.1 to 0.3°C per hour

Aperture Type/Diameter: Cooled Round, 3.15 inches (80 mm)

Temperature Resolution: 0.1°C

Measuring Accuracy: ± 0.3% of full scale + 1.0°C

D. Model: CBB15GC

Working Temperature: Ambient 5° to 300°C (not pictured)

Environment Temperature: 0° to 40°C

Temperature Stability: ± 0.1 - 0.3°C per hour

Aperture Type/Diameter: Uncooled Round, 3.9 inches (100 mm)

Temperature Resolution: 0.1°C

Measuring Accuracy: ± 0.3% of full scale + 1.0°C

Surface Hot Plate Type with External Temperature Controller

E. Model: CBB16KC, **Working Temperature:** -20° to 60°C

Model: CBB16LC, **Working Temperature:** -40° to 60°C

Environment Temperature: 0° to 40°C (≤ 20°C when working at -20°C)

Temperature Stability: ± 0.3 to 0.5°C per hour

Aperture Type/Diameter: Uncooled Round, 5.90 inches (150 mm)

Temperature Resolution: CBB16KC: 0.1°C, CBB16LC: 0.01°C

Measuring Accuracy: ± 0.3% of full scale + 0.5°C

F. Model: CBB18GC

Working Temperature: Ambient 5° to 300°C

Environment Temperature: Blackbody: 40° to 60°C; Controller: -5° to 50°C

Temperature Stability: ± 0.1 to 0.2°C per hour

Aperture Type/Diameter: Uncooled Square, 11.81 x 11.81 in (300 x 300 mm), accuracy tolerances in center 8" x 8" area.

Temperature Resolution: 0.1°C

Measuring Accuracy: ± 0.5% of full scale + 1.0°C

G. Model: CBB18MC

Working Temperature: -45° to 70°C

Environment Temperature: Blackbody: -40° to 60°C; Controller: -5° to 50°C

Temperature Stability: ± 0.03 to 0.06°C per hour

Aperture Type/Diameter: Cooled Round, 11.81 inches (300 mm)

Temperature Resolution: 0.01°C, when > -20°C

Measuring Accuracy: ± 0.5% of Reading when ± 1.0°C

Specifications subject to change without notice



I

Cavity Type

I. Model: CBB21CC
Working Temperature: 800° to 1450°C
Environment Temperature: 0° to 40°C
Temperature Stability: ± 2.5°C per hour
Aperture Type/Diameter: Cooled Round, 1.18 inches (30 mm)
Temperature Resolution: 1°C
Measuring Accuracy: ± 0.4% of full scale +1.0°C

J. Model: CBB21DC
Working Temperature: 800° to 1600°C
Environment Temperature: 0° to 40°C
Temperature Stability: ± 2.5°C per hour
Aperture Type/Diameter: Cooled Round, 1.18 inches (30 mm)
Temperature Resolution: 1°C
Measuring Accuracy: ± 0.4% of full scale +1.0°C



H

H. Portable Calibration Black Body

Model: HSICBB-P
System Accuracy: ± 0.3°F or ± 0.2°C over entire range
Radiator: 3" diameter concentric rings with integral 4-wire RTD sensor
Meter: 4-wire RTD thermometer
Ambient Operating Range: -40° to 158°F (-40° to 70°C)
Scale: °F or °C user selectable
Display: 4-digit 1" high LCD
Display Resolution: 0.1°
Display Update Rate: 10 seconds
Repeatability: 0.1° F or C
Power: 2 AA Lithium Thionyl Chloride Batteries
Case Rating: IP67 Pelican case (1 meter submersion for 30 minutes with case closed)



J



K. Model: CBB22BC
Working Temperature: 300° to 990°C
Environment Temperature: 0° to 40°C
Temperature Stability: ± 0.5 to 1.0°C per hour
Aperture Type/Diameter: Cooled Round, 1.97 inches (50 mm)
Temperature Resolution: 0.1°C
Measuring Accuracy: ± 0.3% full scale + 1.0°C



L

L. Model: CBB22JC
Working Temperature: 50° to 500°C
Environment Temperature: 0° to 40°C
Temperature Stability: ± 0.1 to 0.3°C per hour
Aperture Type/Diameter: Cooled Round, 1.97 inches (50 mm)
Temperature Resolution: 0.1°C
Measuring Accuracy: ± 0.3% full scale + 1.0°C

Infrared

Digi-Stem

Hand Held Meters

Sensors

Temp-Plates

Thermometers

Thermowells

Recorders

Pressure Gauges

Calibration

Portable & Benchtop Style Calibrators

Your choice for quality made calibrators with the accuracy to meet your needs

A. Programmable Benchtop Micro-Ohmmeter

Model: OM21 For measurement of thermistors and heat-sensitive components

Calibration: Calibrated electronically, no internal adjustments needed

Sensing Element: 4 wire terminal

Interface: RS232 or IEEE 488-2 link

Display Resolution: High resolution 0.1 $\mu\Omega$ up to 20 k Ω

Meter Accuracy: 0.03%

Memory: 1000 measurements

Range: Eight measurement ranges

Options: Battery and charger, IEEE 488-2, Software, Cables, Clamps, Rack Mount and Carrying Case



A

B. Industrial Benchtop Micro-Ohmmeter

Model: OM22 Designed for Industrial test; preconfigured or user programmable

Calibration: Calibrated electronically, no internal adjustments needed

Sensing Element: 4 wire terminal

Interface: RS232 and IEEE 488-2 programmable

Display Resolution: High resolution 0.1 $\mu\Omega$ up to 20 k Ω

Meter Accuracy: 0.03%, 26,000 counts

Memory: 1000 measurements

Range: Eight measurement ranges

Options: Battery and charger, IEEE 488-2, Software, Cables, Clamps, Rack Mount and Carrying Case



B



C

Portable Micro-Ohmmeter

OM16 Portable Micro-Ohmmeter is designed for outdoor or indoor use. Easy to use, the OM16 performs measurements on inductive and non-inductive resistances with a DC current. Its large interactive display informs the operator in real time about the type of measurement, range, calculation conditions (resistance calculated according to a reference temperature), thresholds status and values. Designed for harsh environments, it is encased in a Pelican® carrying case and features a washable plastic keyboard and key-locked measurement plugs.

C. Portable Micro-Ohmmeter

Model: OM16 Designed for harsh environments

Sensing Element: 4 wire configuration

Measurement Plugs: 2 Circular Locking Connectors, Protection up to 250V Fuse Protection

Interface: RS232

Display Resolution: 0.1°C

Meter Accuracy: $\pm 0.5^\circ\text{C}$ @ $23^\circ\text{C} \pm 5^\circ\text{C}$

Memory: 1000 measurements

Range: Measuring current adaptable to the measuring range from 10A to 100mA

Approvals: IP53 according to EN60529; EN61010-1, Category II, Pollution 2



Specifications subject to change without notice

MIL-SPEC Soldering Iron Tester

- MIL-SPEC compliant millivolts AC only test with pass/fail warning light for voltage
see video at www.palmerwahl.com/soldering_iron_tester.php
- Pass/fail warning light for resistance test, user selectable 2 or 5 ohms
- Output to recorder: 1 mV, 100 mV/mV, 100 mV/ohm
- Transient voltage spike detector detects transients over 100 mV and 1µs pulse width
- Built-in thermocouple connector for Type K probes, wire probe included
- Function selection switch for fast tests without moving the iron tip
- Auxiliary AC convenience outlet powers iron under test and insures common ground with the tester
- Comprehensive Operators Handbook with calibration instructions and troubleshooting guide
- ESD safe construction
- Wrist strap tester verifies strap integrity

The First universal soldering iron tester with digital display was developed by Wahl in 1986

The portable high performance ST2200 Soldering Iron Tester measures soldering iron performance in seconds under actual soldering iron conditions - no need to disassemble the soldering iron prior to test. The convenient simple-to-operate tester was designed to conform with testing for Soldering Standard IPC/EIA J-STD-001C and MIL-SPEC compliant to assist users in producing consistent, quality solder joints. Prevent damage from electrostatic discharge, electrical leakage, or induced voltage to safeguard critical semi-conductor and integrated circuit components. Unit is NIST Traceable.

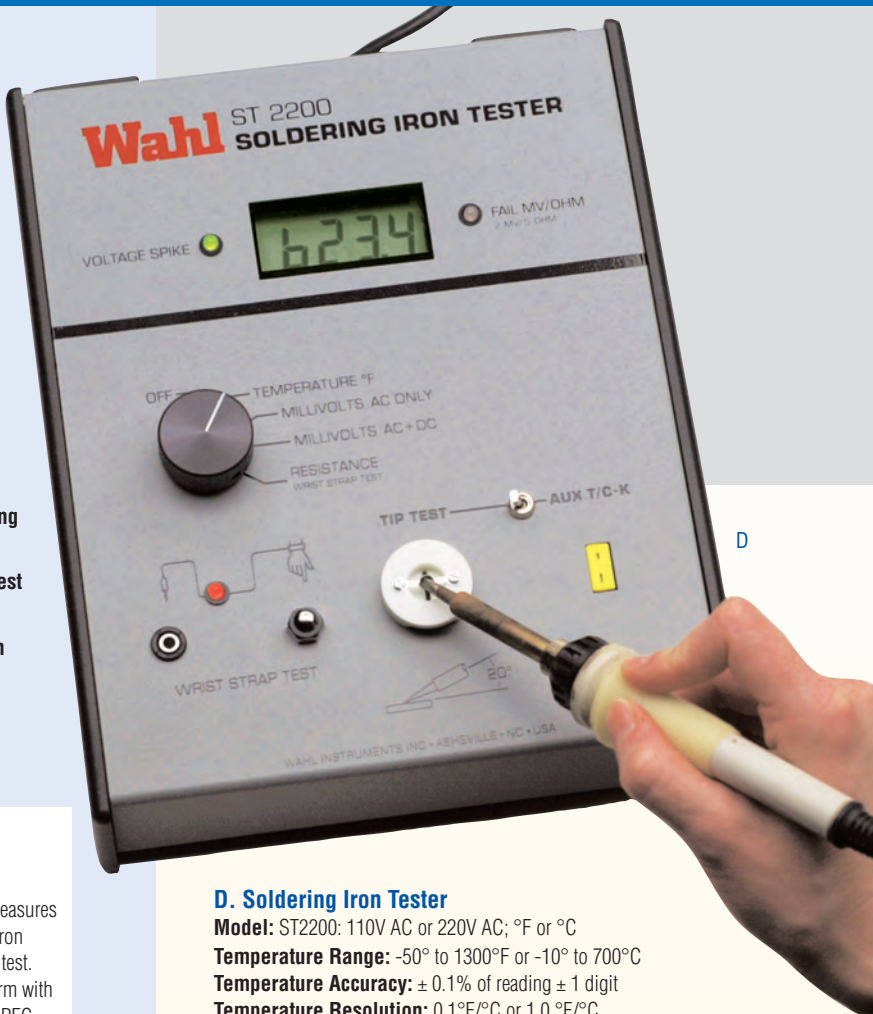

D. Soldering Iron Tester

Model: ST2200: 110V AC or 220V AC; °F or °C
Temperature Range: -50° to 1300°F or -10° to 700°C
Temperature Accuracy: ± 0.1% of reading ± 1 digit
Temperature Resolution: 0.1°F/°C or 1.0 °F/°C
Tip Ohms Range: 0-99.9 Ω
Tip Ohms to Ground Accuracy: 0-20 Ω ±0.1 Ω, 20-100 ±0.5% of reading
Tip Ohms to Ground Resolution: 0.01 or 0.1Ω
Tip mV to Ground Range: 0 - 30mV
Tip mV to Ground Accuracy: ± 0.1mV
Tip mV to Ground Resolution: 0.01mV or 0.1mV
 North American, European, or British style plug and receptacle

Precise Thermocouple Sensors simulate actual solder joints to verify soldering iron integrity



E1

E2

E3



E. Sensors for Soldering Iron Testers

E1. WST-02 Sensor: High temperature Type K ribbon thermocouple, stainless steel support strap, solder bead and glass filled Teflon body (housing). Measures tip temperature of most small (< 1/8") conical, chisel and screwdriver type soldering tips, (shown on tester above). Heavy duty sensor. Small to medium tips 0.2 gram mass.

E2. WST-02B Bonnet Sensor: Same as above, but with a "bonnet" which acts as a position stop to guide iron tips for repeatable measurements in the identical position. It also stabilizes the tip to prevent movement during measurement which can cause temperature fluctuations.

E3. WST-03 Elevated Wire Sensor: Welded thermocouple wire sensor, support posts and glass filled Teflon body. May be used when the iron tip is not compatible with the WST-02 sensors. Allows the operator to measure temperature at an exact point on the iron tip. For all tip sizes.



Wahl designs and manufactures to the most stringent quality standards. We provide certified, traceable calibration data in support of companies who require meeting ISO 9001:2008, FAA, and FDA quality standards. Calibrations to both IPTS-68 and ITS-90 are available.

Calibration Services

STANDARD CERTIFICATION: Unit is calibrated to factory specifications using NIST traceable equipment.

Certificate of Conformance - Statement that our product meets published specifications. Included on the packing list with each shipment.

Long Form Certificate of Conformance - Available upon request, includes Certificate of Conformance with customer's PO number, items shipped, and any product serial numbers for products included in the shipment.

Calibration Sticker - (or tag) Advising you of the date your instrument(s) was/were calibrated, and the suggested date for the next calibration. This is provided with most products at time of purchase, and when you return a product for calibration.

NIST TRACEABLE TEST REPORT: Unit is calibrated to factory specifications using NIST Traceable equipment. Provides instrument test data with details of standard instruments used to perform the calibration. "As Received" and "As Left" Test Data is provided, as appropriate, with any out of tolerance conditions noted, and a unique test number assigned.



NIST Traceable Calibration Sticker provides the date your instrument(s) was/were calibrated, technician performing the calibration, suggested date for the next calibration, and references the unique test number shown in the test report.

Our Quality Management system is certified to conform to ISO9001:2008. We maintain a calibration system in conformance with ANSI/NCSL Z-540 and MIL-STD-45662A.

REGISTER YOUR PRODUCT: Registration is fast and easy. Register your product for Warranty Protection and our Calibration Reminder Service to keep your QC program in compliance. Go to: www.palmerwahl.com/register.

Repair and Other Services

Palmer Wahl offers repair and calibration services on most products we sell. The customer will receive a written estimate for approval before proceeding with work. Repair pricing includes Standard Certification as listed above.

Detailed Repair Report - Available upon request, this report provides details of evaluation and repairs made.

Custom Points - Palmer Wahl will calibrate your instruments at your specified temperature or pressure points.

Special Requests - When calibrating your instrument, our experienced personnel will help you to achieve the level of quality you require in your facility. Note: Before returning your product please call Customer Service at 1-800-421-2853 or go to www.palmerwahl.com and click on Service/Product Return Request.

Engineering Services - WE CAN DO IT!

Our 175 plus years of experience with temperature and pressure means we're the go-to guys. Our USA based engineering department can work with you to solve your specific problem – if one of our standard products doesn't meet your needs, we can work with you to build a custom solution. We regularly design specialty temperature probes, thermowells, and temperature systems to meet the specific needs of our customers. Because we have our own machine shop, we don't have a minimum order requirement – if you need just one, we can do it. If your application requires specialty material or testing – we can do it!

Palmer Wahl Warranty

Manufacturer warrants all products listed in this catalog to be free from defects in material or workmanship under normal use and service. The Manufacturer agrees to repair or replace any product which upon examination is revealed to have been defective due to faulty workmanship or material if returned to our factory, transportation charges prepaid, within the product specific warranty period stated in the catalog by the manufacturer. This warranty is in lieu of all other warranties, expressed or implied and of all obligations or liabilities on its part for damages including but not limited to consequential damages, following the use or misuse of instruments sold by the Manufacturer. No agent is authorized to assume for manufacturer any liability except as set forth above.

Palmer Wahl products are available from:

Palmer Wahl
 234 Old Weaverville Road
 Asheville, North Carolina 28804
 Phone: (800) 421-2853 • (828) 658-3131
 Fax: (828) 658-0728 • Email: info@palmerwahl.com
www.palmerwahl.com www.wahlheatspy.com
www.palmermpt.com www.wahltempplates.com

Digital version of catalog may differ from printed version

ISO 9001:2008
 CERTIFIED QUALITY
 MANAGEMENT SYSTEM