

# Technical Datasheet



## Sentry Series - Flameproof Differential Pressure Switch

Models: HD01, HD02 & HD03

### Key Features

- SPDT & DPDT Switch Outputs
- Aluminium Epoxy Coated Weatherproof Enclosure IP66/NEMA4X
- ATEX / IECEx Flameproof
- 316 Stainless Steel Wetted Parts as Standard.
- Field Adjustable Set-points Against a Reference Scale
- Pressure Ranges up to 10bar (160psi)
- Maximum Working Pressure up to 250bar (3500psi)
- Safety Vented Design as Standard
- Suitable for use SIL 2 safety related systems

### Series Overview

The Sentry Series offers exceptional performance and high build quality in a simple, safe and cost-effective package.

- Performance is assured by repackaging Delta's well proven sensor technologies in a new, simple, one-piece enclosure.
- Safety is maintained by a vent that prevents the enclosure becoming pressurized in the event of a sensor being damaged.
- Cost is minimised through the selection of common standard options although, as with all Delta products, a variety of optional extras are available to tailor the product to specific needs.

Other products in the series include:

- Pressure Switches: Model P0
- Temperature Switches: Model T0



### Product applications

The Sentry Series is suitable for a wide range of applications in:

- Process plants
- OEM equipment

The choice of models available ensures that the Sentry Series is suitable for use in:

- Zone 1 & 21 Hazardous Areas
- SIL 2 safety related systems

### How can we help you?

Delta Controls' offers fast, efficient and knowledgeable support when and where you need it. Please visit our web site at [www.delta-controls.com](http://www.delta-controls.com) to find your local support centre or call us on:

+44 (0)1252 729 140

**Sentry Series - Flameproof**  
Models: HD01, HD02 & HD03

## How to order

Switches can be configured by selecting codes representing the desired features from the tables that follow. The chart below, describes how the model code is built up. For assistance in configuring a switch that best suits your needs, please contact your local sales office.

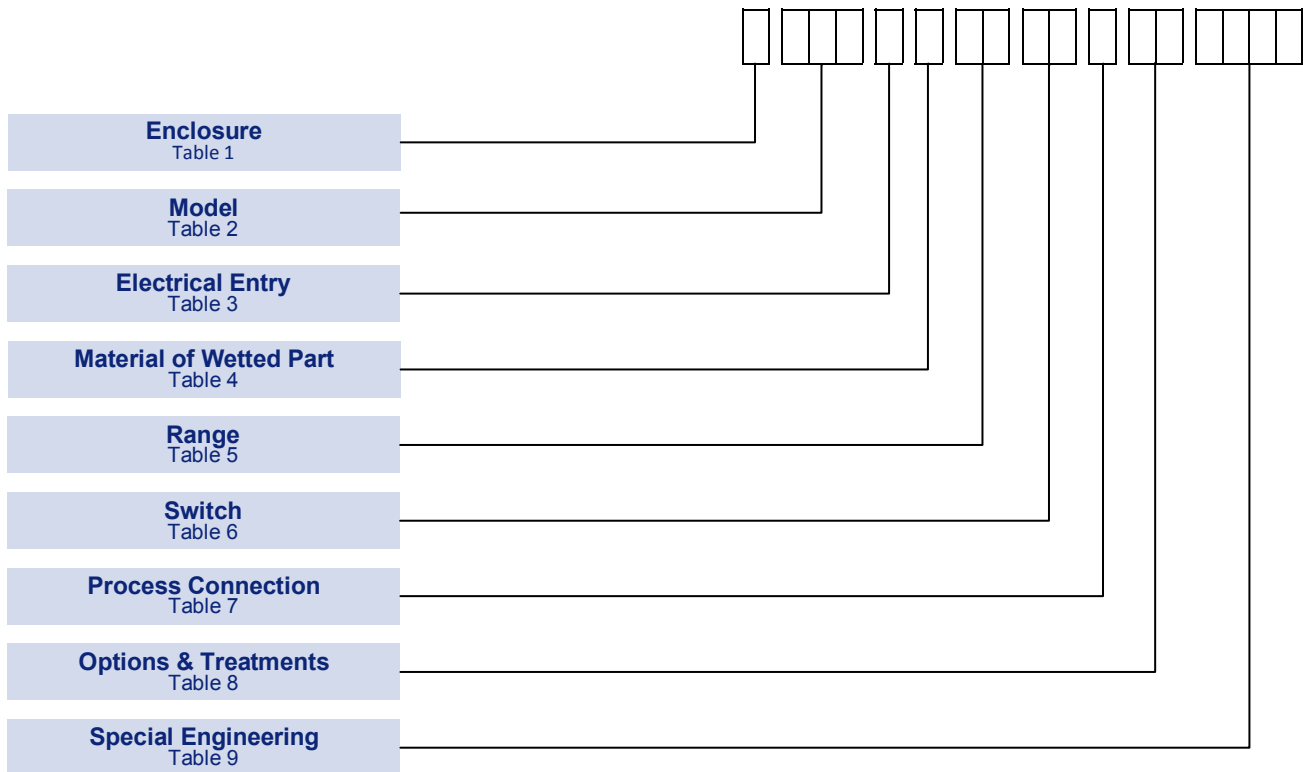

**NOTE:** Options shaded in the following tables are the most common options and are available on the quickest lead-times and at the lowest cost.

**NOTE:** Only the most common options are shown in this data sheet. Should you require a feature that is not shown, please contact your local sales office for further details.

## Technical Specification

Sentry Series - Flameproof  
Models: HD01, HD02 & HD03

<b>Accuracy:</b>	Set point repeatability $\pm 1\%$ of span at 20°C / 68°F
<b>Storage Temperature:</b>	-40 to +60°C / -40 to +140°F
<b>Ambient Temperature:</b>	-25 to +60°C / -13 to +140°F
<b>Maximum Process Temperature:</b>	Subject to appropriate installation practice, the component parts with stand up to +60°C (+140°F).
<b>Enclosure classification:</b>	IP66 / NEMA 4X / Flameproof Ex d
<b>Switch output:</b>	SPDT or DPDT snap action microswitch (standard) Hermetically sealed (optional)
<b>Electrical rating:</b>	See Table 6
<b>Process Connection:</b>	Rc ¼ (¼ BSP Tr INT) to ISO 7/1 (standard) ¼ -18NPT INT (optional) Others via adapter optional)
<b>Weight:</b>	3.2kg / 7lb - 9.6kg / 21.2lb depending on model

## Enclosure

All enclosures die-cast in aluminium, epoxy painted, with weather protection not less than NEMA type 4X / IP66

TABLE 1

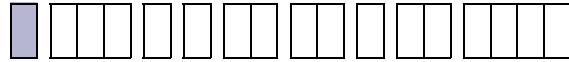

	Code
<b>Flameproof</b> ATEX / IECEx approved for use in a Zone 1 & Zone 21 hazardous locations.  II 2GD Ex d IIC T6 / T5 Ex tb IIIC T85°C / T100°C Gb IP66 T6 / T85°C (Tamb -30°C to +65°C)	H

## Models

### D01

For applications between -12.5mbar to 12.5mbar, maximum working pressure 1 bar (14.5 psi).

### D02

For applications up to 10 bar (160 psi), maximum working pressure 110 bar (1600 psi).

### D03

For applications up to 10 bar (160 psi), maximum working pressure 250 bar (3500 psi).

TABLE 2



		Code
<b>Differential Pressure</b>	Diaphragm Operated <b>Low Pressure</b>	D01
<b>Differential Pressure</b>	Diaphragm Operated <b>Standard Pressure</b>	D02
<b>Differential Pressure</b>	Diaphragm Operated <b>High Overload Pressure</b>	D03

## Electrical Entry

TABLE 3

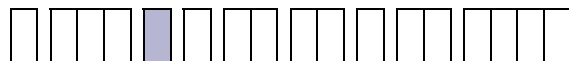

Description	Code (Single Entry)	Code (Dual Entry)
M20 x 1.5 Internal ISO Thread	0	5
½ NPT Internal Thread	2	4

## Material of Wetted Parts

TABLE 4



Ranges		Code
BD-EA	316 Stainless steel diaphragm. All other wetted parts fully austenitic 300 series stainless steel, PTFE and Nitrile seals.	I
BD-EA	For wetted parts required to conform with Sour Gas or Sour Crude, applications as laid down in NACE standard MR-01-75	L
BC	Nitrile diaphragm and seal with aluminium flanges	D

## Setting Ranges

The instruments will sustain, without loss of performance, a continuous forward over pressure equal to the maximum static pressure and/ or full Vacuum

**NOTE:** For pressure difference switches maximum working pressure ( $P_{max}$ ) and maximum static/line pressure mean the same.

\* Forward overpressure is limited to 500 mbar

Maximum static/line pressure applied in the reverse direction (i.e., to low pressure connection with high pressure connection open to atmosphere) will be contained without failure. The diaphragm on ranges BD to EA (BY to EH) will however have been distorted, leading to a degradation of performance and a shortening of the service life.

TABLE 5

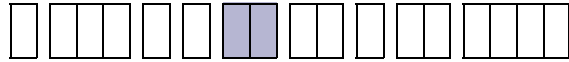

Model	Range				Deadband**	
	mbar/bar	Code	in H2O/psi	Code	mbar	in H2O/psi
D01	-12.5 to +12.5	BC*	-5.0 to +5.0	BU*	2	1.2
D02	6 to 40	BD	2.5 to 16	BY	5	2.0
(D03)		(0D)		(0Y)		
D02	25 to 160	CB	10 to 64	CS	16	6.4
(D03)		(0B)		(IS)		
D02	100 to 600	CE	1.5 to 8.5	CK	22	0.3
(D03)		(0E)		(0K)		
D02	0.4 to 2.5	DC	6 to 40	DP	120	1.7
D03						
D02	0.6 to 4	DD	10 to 60	DT	210	3.0
D03						
D02	1.6 to 10	EA	25 to 160	EH	420	6.1
D03						

\*\* Deadband figures are typical for Code 10 SPDT 15A microswitches (see table 6) with falling set-points at mid-scale. Deadbands for other microswitch options may differ. Due to manufacturing tolerances the figures quoted are for guidance only. Should the differential be critical for specific applications, our engineers should be consulted before ordering.

## Switch Options

TABLE 6

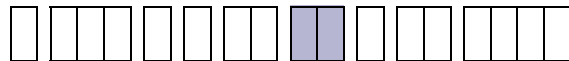

UL/CSA Rating (RESISTIVE) §SEE NOTE	IEC 947-5-1/EN 60947-5-1 RATING							Contact	Code
	Designation & Utilization Category	Rated operational current le (A) at rated operational voltage Ue	U <sub>i</sub>	U <sub>imp</sub>	VA Rating				
					Make	Break			
5 A @ 110/250V AC Light Duty for AC only	AC14 D300	0.6/0.3A @ 120/240V AC	250V	0.8kV	AC	432	72	SPDT	00
	DC13 R300	0.22/0.1A @ 125/250V DC			DC	28	28	DPDT	01
1 A @ 125V AC & §100 mA @ 30V DC gold alloy contacts for low voltage switching	1 A @ 125 VAC RESISTIVE (IEC 1058-1/EN 61058-1)							SPDT	04
								DPDT	05
15 Amp @ 125/250/480 V AC & 2 A @ 30V DC General purpose precision	AC14 D300	0.6/0.3A @ 120/240V AC	250V	0.8kV	AC	432	72	SPDT	10
	DC13 R300	0.22/0.1A @ 125/250V DC	250V	0.8kV	DC	28	28	DPDT	11
5 A @ 250V AC and 2 A @ 30V DC Hermetically sealed. Gold plated silver contacts.	AC14 D300	0.6/0.3A @ 120/240V AC	250V	0.5kV	AC	432	72	SPDT	H2 <sup>^</sup>
	DC13 R300	0.22/0.1A @ 125/250V DC			DC	28	28	DPDT	H3† <sup>^</sup> H6‡ <sup>^</sup>

† 2 Single pole, double throw, simultaneous falling under pressure

‡ 2 Single pole, double throw, simultaneous rising under pressure

<sup>^</sup>Terminal Block supplied as standard

Note: For Low energy circuits e.g 30V and up to 100mA, we recommend using gold alloy contact switches

U<sub>i</sub> = rated insulation voltage; U<sub>imp</sub> = rated impulse to withstand voltage across contacts.

In the absence of any verification by UL/CSA the microswitch § manufacturer's rating is stated in **italics and bold**.

If in doubt seek guidance from the factory.

## Process Connection

TABLE 7



	Code
Rc ¼ (¼ BSP Tr INT) to ISO 7/1: Direct	A
¼ NPT F: Direct	F

## Options & Treatments

TABLE 8



	Code
Stainless steel wired on tag	30
Applies when – no option is required and selection is made from special engineering (see Table 9)	00

## Special Engineering

TABLE 9



Last 4 digits of model code only used when special engineering is required.

	Code
Please consult Delta sales engineering for special requirements	TBA

## Approvals

### EUROPEAN



**Low voltage Directive (LVD) 2006/95/EC.**  
Compliant to LVD

**Pressure Equipment Directive (PED) 97/23/EC:**

This product has a process connection size  $\leq$  DN25 and is therefore categorised as sound engineering practice under Cat 3.3



**ATEX Directive 94/9/EC:**

Ex d IIC T6 / T5  
Ex tb IIIC T85°C / T100°C Gb IP66  
T6 / T85°C (Tamb –30°C to +65°)

Certificate No. Baseefa12ATEX0121  
IEC 60079-0, EN 60079-1, EN 60079-31



### GLOBAL CERTIFICATION

**IECEx Certified**

Ex d IIC T6 Gb  
Ex tb IIIC T85°C Db IP6X  
(-30°C ≤ Ta ≤ +65°C)

Certificate No. IECEx BAS 12.0081  
IEC 60079-0, IEC 60079-1, IEC 60079-31



**Functional Safety Certified**

Meets the requirements of IEC 61508-2:2010 for use in SIL 2 safety related systems

Certificate No. Sira FSP 12015/01

# Dimensions

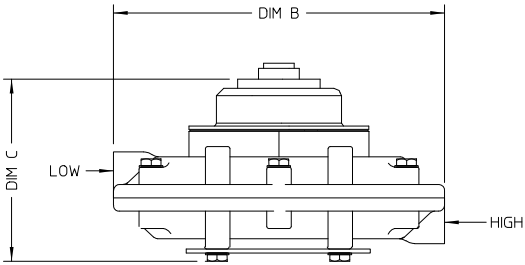
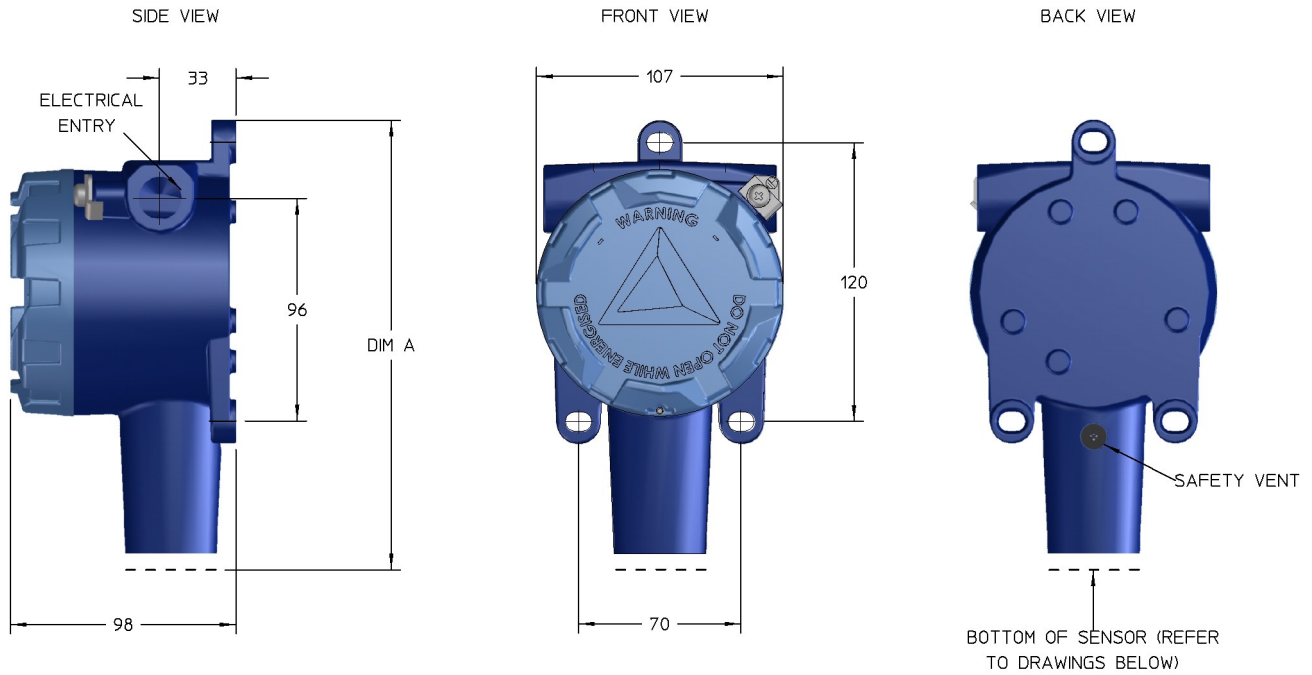

D01 SENSOR  
(RANGE BC)  
Pmax = 1 Bar

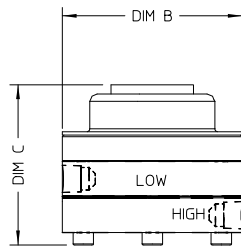

D02 SENSOR  
(RANGES BD - EA)  
Pmax = 110 Bar

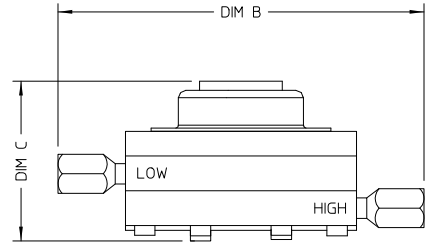

D03 SENSOR  
(RANGE BD - EA)  
Pmax = 250 Bar

Model	Range	DIM A	DIM B	DIM C
D01	BC	258	162	89
D02	BD - CE	246	114	77
	DC - EA	246	88	77
D03	0D - 0E	271	192	102
	DC - EA	271	166	102

**Sentry Series - Flameproof**  
 Models: HD01, HD02 & HD03

In the interest of development and improvement Delta Controls Ltd, reserves the right to amend, without notice, details contained in this publication. No legal liability will be accepted by Delta Controls Ltd for any errors, omissions or amendments.

**Delta Controls Limited**

Riverside Business Park, Dogflud Way, Farnham, Surrey GU9 7SS, UK.

T+44 (0)1252 729 140 F+44 (0)1252 729 168 E sales@delta-controls.com W www.delta-controls.com



FM00720