

HYGROFLEX3



TECHNOLOGY

THE ADVANCED HVAC TRANSMITTER.

INTRODUCING AIRCHIP DIGITAL TECHNOLOGY.

INNOVATION IN HUMIDITY AND TEMPERATURE MEASUREMENT

- Relative humidity, temperature measurement and dew point calculation
- Outstanding accuracy and repeatability
- Hygromer® IN-1 humidity sensor
- Auto-diagnostics and automatic correction
- Freely selectable and scalable analog outputs



rotronic
MEASUREMENT SOLUTIONS

HYGROFLEX3-SERIES

SPECIFY THE BEST: HYGROFLEX3 ADVANTAGES AT A GLANCE.

The new HygroFlex3-series is the latest development in HVAC transmitters for relative humidity, temperature and dew point. Based on AirChip3000 technology, the instruments achieve a degree of accuracy not seen before.

In combination with advances in sensor technology and integration, the HygroFlex3-series provides superb precision and state-of-the-art functionality, taking humidity, temperature and dew point measurement to a whole new level of performance and reliability ($\leq 2\% \text{rh} / 0.3 \text{ K}$).

Highly versatile

- One or two selectable and scalable analog outputs
- Analog outputs assignable to relative humidity, temperature or dew point
- 2-wire or 3/4-wire systems available



TECHNOLOGY

AirChip3000

- Compensates humidity and temperature over 30,000 reference points
- 2,000 data point memory
- Dew/frost point calculation
- Sensor auto-diagnostics and automatic correction
- Active alarming and information
- ASIC (Application Specific Integrated Circuit), micro-controller and EEPROM on one chip

Fast response and precision measurement

- By decoupling the Pt100 temperature sensor from the probe, thermal response is significantly improved
- Use of Pt100 Class A sensors for maximum accuracy

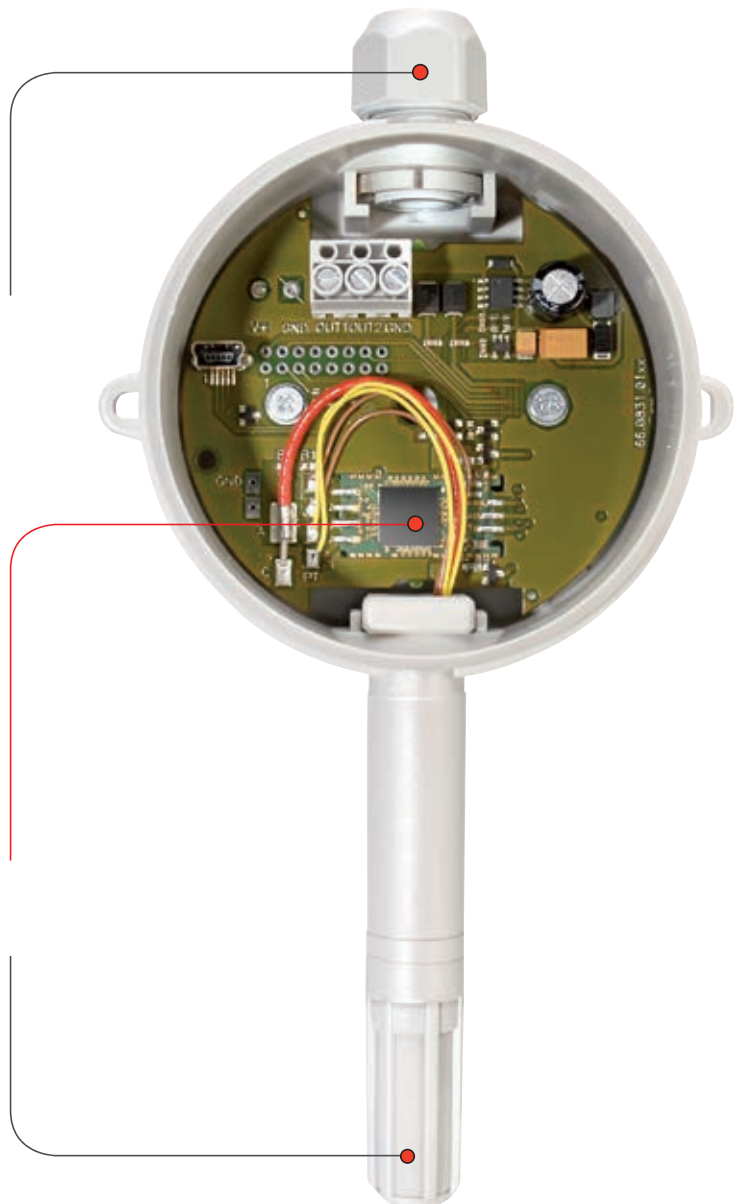

APPLICATIONS.

The HygroFlex3-series is ideal for all applications where exact measurement of humidity and temperature is of decisive importance. The transmitters can be used in a variety of fields for heating, ventilation and air conditioning applications, greenhouses, museums, warehouses, libraries, railway stations and for climate control in office buildings.

Thanks to the exceptional long-term stability of the sensors and auto-diagnostics, the transmitters are both service-friendly and reliable and will save you time and money.



HF3 duct version

For use in ventilation shafts



HF3 wall version

For use in technical equipment rooms



HF3 space version

For use in offices and rooms where appearance is important

OUTPUTS OF THE HYGROFLEX3-SERIES.

The high flexibility of the HygroFlex3-series allows the user to freely select the output parameters and the scale of each output. All you need to do is enter the desired settings using HW4 software.

HF32-series

2-wire technology

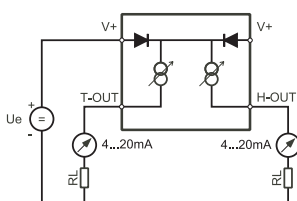

HF33-series

3/4-wire technology

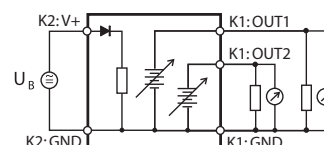
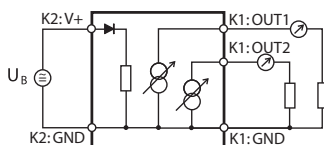

TECHNICAL INFORMATION.

Sensor Diagnostics.

The intelligence of AirChip3000 technology enables advanced sensor diagnostics. Should the sensors deviate from factory defined parameters, measurement values can be compensated automatically.

Data Logging and Alarm Generation.

Up to 2,000 measurement values can be stored in the HygroFlex3 transmitter; the user is able to configure the measurement interval, set alarm limits, scale the output signal and download data using optional ROTRONIC HW4 software. The output signals of the HF3 can be programmed to take a fixed value in the event of a major sensor failure.

Wall version (W)

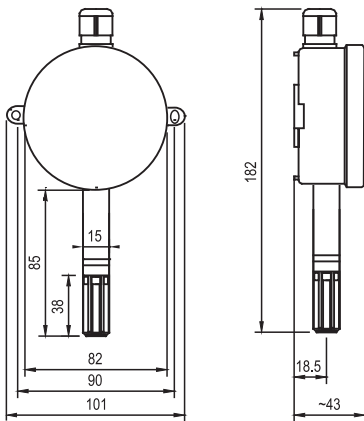

Space version (S)

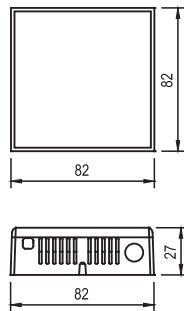

Duct version (D)

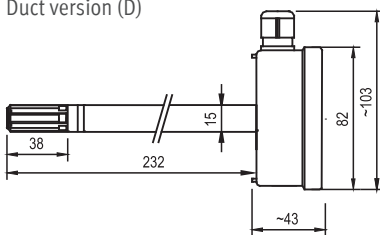

Space version (R)

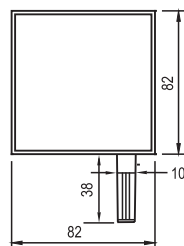

	HF32: 2-wires	HF33: 3/4-wires
Integrated sensors	Yes	
Humidity sensor	ROTRONIC Hygromer® IN-1	
Temperature sensor	Pt100 Class A	
Accuracy at 23 ±5 °C	±2.0 %rh / 0.3 K (±1.0 %rh / 0.1 K Type R)	
Resolution AirChip3000	<0.02 %rh / 0.01 K	
Long-term stability humidity sensor	<1 %rh / year	
Response time τ 63	<10 s	
Measurement range	-40...60 °C / 0...100 %rh	
Electronics operating range	-40...60 °C / 0...100 %rh (-10...60 °C with LCD)	
Display (Space version only) (HF32S: no backlight)	Graphic LCD Parameters freely configurable	
Alarm functions (programmable)	Open or shorted sensor	
Output signals	Freely scalable by user 0...1 V, 0...5 V, 0...10 V, 0(4)...20 mA	
Change in signal type	HF33 only	
Power supply	HF32: 10...28 VDC: 10 V + (0.02 x load) HF33: 18...40 VDC/13...28 VAC	
Power consumption	HF32: max 40 mA, other models <150 mA	
Circuit type	HF32: 2 x 2 wires, HF33: 3/4 wires	
Min. / Max. load	V-signal: ≥1 kΩ/V / mA signal: ≤ 500 Ω	
Firmware update	Via service connector, requires HW4 software	
Sensor diagnostics (Drift, state)	Programmable. Default: off	
Sensor protection	Polyethylene filter	
Max. air velocity	20 m/s at probe	
Adjustments	Via ROTRONIC accessories Humidity: multi point; 2 points	
Data logging	Internal, 2000 data point memory	
Dew point /Frost point calculation	Yes	
PC interface (service connector)	With ROTRONIC interface cable, HW4 compatible	
Housing material / weight	ABS / approx. 120g	
Cable connections	1 x M16x1.5, on terminals	
Standards	CE- compliant, 2007/108/EG	
Audit trail, Electronic Records	FDA CFR21 Part 11 and GAMP compliant	
IP protection rating & fire protection class	IP65 / Corresponds to UL94-HB	

Subject to technical change without notice. Errors and omissions excepted.

Interested in further information (special applications, order codes)? A complete and up-to-date overview or Dew/Frost point our HygroFlex3-series is available on our web site www.rotronic.com.

Change over now to AirChip3000 technology for your temperature and humidity measurements. You can find detailed information about our probes at www.rotronic.com. We would also be happy to advise you in person or on the phone.

ROTRONIC AG, Grindelstrasse 6, CH - 8303 Bassersdorf, Tel. +41 44 838 11 11, Fax +41 44 838 14 83, www.rotronic.ch
 ROTRONIC Instruments (UK) Ltd, Crompton Fields, Crompton Way, Crawley, West Sussex, RH10 9EE, UK, Phone +44 (0)1293 571000, Fax +44 (0)1293 571008, www.rotronic.co.uk
 ROTRONIC Instrument Corp, 135 Engineers Road, Hauppauge, NY 11788, USA, Phone, +1 631 427-3898, Fax, +1 631 427-3902, www.rotronic-usa.com
 ROTRONIC Instruments Pte. Ltd., 1003 Bukit Merah Central, #06-31 Inno Centre, Singapore 159836, Phone +65 6376 2107, Fax +65 6376 4439, www.rotronic.sg

rotronic
MEASUREMENT SOLUTIONS